

# DELTA EVO

Design - Engineering  
 C.S.R. LAS MOBILI

Conforme al DLGS 81/2008 (già 626/'94)  
 apply to RULE 81/2008 (626/'94)

## IMPORTANTE / it's very important

SULL'ORDINE INDICARE SEMPRE IL CODICE COMPLETO A 9 CIFRE  
 always indicate on the order the complete 9-digit code

ESEMPIO: PER ORDINARE 1 SCRIVANIA **ART.010** ROVERE INDICARE IL CODICE =  
 example: to order 1 DESK **ART.010** OAK indicate the code =

	155	010	733
DECODIFICA decoding	MODELLO model	ARTICOLO art.cdc.	CODICE FINITURA (*) finish code (*)



Certif. n°07-08/2019

In vigore dal:  
 Valid from:  
 01/01/2018

Valido fino a nuova emissione  
 Valid until new emission

## SOMMARIO / summary

<b>CARTELLA COLORI</b> .....	<b>3</b>
<i>colours samples card</i>	
<b>ABBINAMENTI COLORI</b> .....	<b>3</b>
<i>matching colours</i>	
<b>SCRIVANIE DIREZIONALI</b> .....	<b>5</b>
<i>executive desks</i>	
<b>ALLUNGO</b> .....	<b>6</b>
<i>extension</i>	
<b>CANALI PORTACAVI PER SCRIVANIE</b> .....	<b>6</b>
<i>cable trays for desks</i>	
<b>SCHEMA DI UTILIZZO CANALI PORTACAVI</b> .....	<b>6</b>
<i>scheme of use cable trays</i>	
<b>CASSETTIERE SU RUOTE</b> .....	<b>7</b>
<i>mobile pedestals</i>	
<b>MOBILI DI SERVIZIO SU PIEDINI</b> .....	<b>7</b>
<i>service units on adjustable feet</i>	
<b>CONTROMOBILI e COMPLEMENTI</b> .....	<b>8</b>
<i>credenzas and complements</i>	
<b>TAVOLI RIUNIONE</b> .....	<b>9</b>
<i>meeting tables</i>	
<b>MOBILI BASSI</b> .....	<b>11</b>
<i>low cabinets</i>	
<b>MOBILI MEDI</b> .....	<b>12</b>
<i>medium cabinets</i>	
<b>MOBILI ALTI</b> .....	<b>13</b>
<i>high cabinets</i>	
<b>TOP + 2 FIANCHI FINALI</b> .....	<b>15</b>
<i>top + 2 final side panels</i>	
<b>RIPIANI REGISTRABILI PER MOBILI</b> .....	<b>15</b>
<i>adjustable shelves for cabinets</i>	
<b>KIT AMMORTIZZATORI (PER ANTE LEGNO)</b> .....	<b>16</b>
<i>dampers set (for wooden doors)</i>	
<b>DESCRIZIONE TECNICA</b> .....	<b>17</b>
<b>TECHNICAL DESCRIPTION</b> .....	<b>19</b>
<b>INDICE DEI CODICI</b> .....	<b>21</b>
<i>codes index</i>	

## METALLI | METALS



**COD. AN 02**  
ANTRACITE | ANTHRACITE

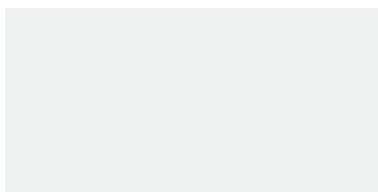

**COD. BI 02** (RAL 9016)  
BIANCO | WHITE



**COD. SG 01**  
STONE GREY | STONE GREY

**CARTELLA COLORI**  
colours samples card



COD. 03  
ROVERE | OAK



COD. 04  
ROVERE GREY | GREY OAK



COD. 06  
NOCE PAVIA | PAVIA WALNUT



COD. 33  
AMARANTO | AMARANTH



COD. 44  
STONE GREY | STONE GREY



COD. 55  
ANTRACITE | ANTHRACITE



COD. 69  
BIANCO BR. | BR. WHITE





COD. 99  
BIANCO SATINATO | SATINED WHITE

ABBINAMENTI COLORI matching colours		COLORI LEGNI wooden colours						
		ROVERE oak	ROVERE GREY grey oak	NOCE PAVIA pavia walnut	BIANCO BR. br. white	AMARANTO amaranth	STONE GREY stone grey	ANTRACITE anthracite
COMPONENTI components								
SCRIVANIE - TAVOLI RIUNIONI desktop - meeting tables	PIANI tops	◇	◇	◇	◇			
	STRUTTURA structure	◇	◇	◇	◇		◇	◇
CASSETTIERE E MOBILI DI SERVIZIO pedestal and service units	FRONTALI - TOP - SCHIENA fronts - top - back panel	◇	◇	◇	◇			
	STRUTTURA structure			◇	◇		◇	◇
CONTROMOBILI e COMPLEMENTI credenzas and complements	STRUTTURA E TOP structure and top	◇	◇	◇	◇		◇	◇
	ELEMENTO LIBRERIA bookcase element				◇	◇	◇	◇
	ANTINE doors	◇	◇	◇	◇	◇	◇	
MOBILI CONTENITORI cabinets	FRONTALI fronts	◇	◇	◇	◇			
	STRUTTURA structure			◇	◇		◇	◇
TOP E FIANCHI FINALI tops and final side panels		◇	◇	◇	◇			

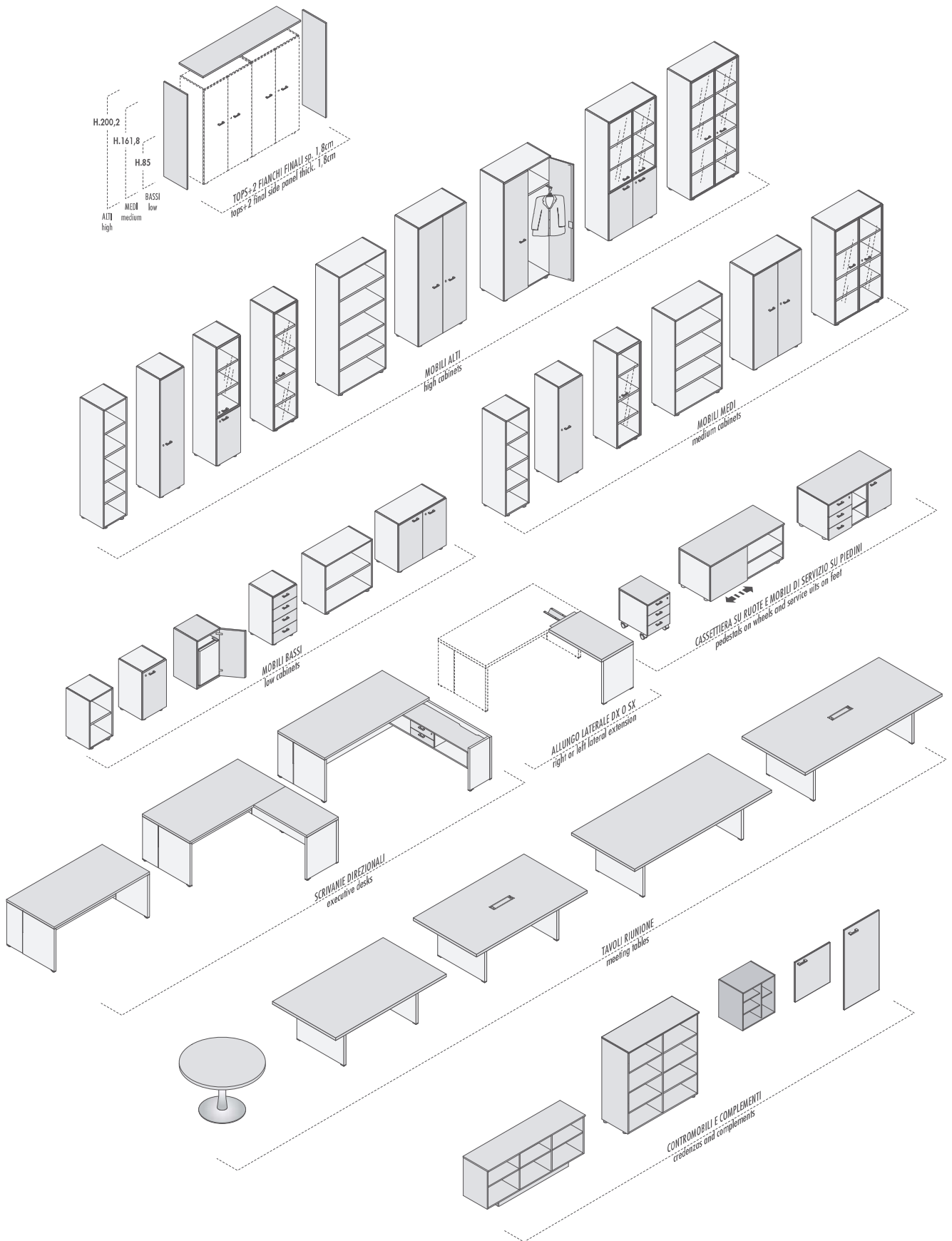
# DELTA EVO

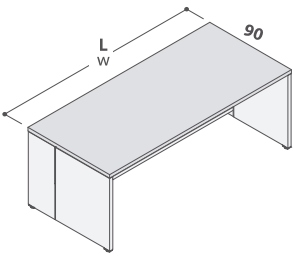
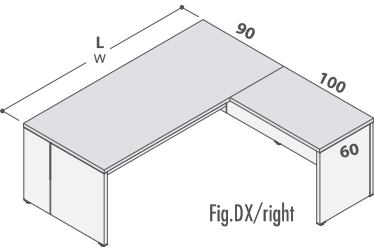
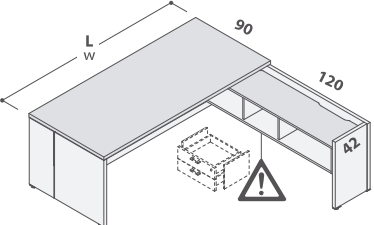

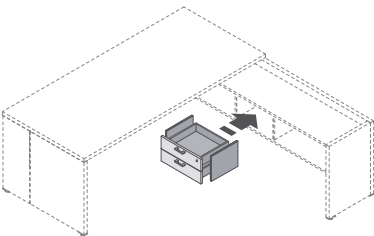
SCRIVANIE DIREZIONALI executive desks								
DESCRIZIONE description	L w	CODICE code	KG	M <sup>3</sup>	COLLI	PREZZO price	(*) CODICE FINITURA (*) finish code	
SCRIVANIE DIREZIONALI executive desks    L. x p.90 x H.75	L.160	155 <b>016</b> (*)	85	0,217	4	€ 351,00		
	L.180	155 <b>010</b> (*)	92	0,233	4	€ 363,00		
	L.200	155 <b>011</b> (*)	98	0,249	4	€ 384,00		
SCRIVANIE DIREZIONALI CON ALLUNGO executive desks with extension   Fig.DX/right  L. x p.190 x H.75	VERSIONE MONO-COLORE / single-color version							
	(*)							
	DX right	L.160	155 <b>232</b> (*)	132	0,333	7	€ 552,00	166 NOCE PAVIA pavia walnut
		L.180	155 <b>218</b> (*)	139	0,349	7	€ 564,00	440 BIANCO BR. br. white
		L.200	155 <b>219</b> (*)	145	0,365	7	€ 585,00	704 ROVERE GREY grey oak
								733 ROVERE oak
	VERSIONE BI-COLORE / double-color version							
	(*)							
	SX left	L.160	155 <b>233</b> (*)	132	0,333	7	€ 552,00	403 ROVERE BIANCO BR. oak br. white
		L.180	155 <b>220</b> (*)	139	0,349	7	€ 564,00	466 NOCE PAVIA BIANCO BR. pavia walnut br. white
L.200		155 <b>221</b> (*)	145	0,365	7	€ 585,00	504 ROVERE GREY ANTRACITE grey oak anthracite	
							566 NOCE PAVIA ANTRACITE pavia walnut anthracite	
							803 ROVERE STONE GREY oak stone grey	
							804 ROVERE GREY STONE GREY grey oak stone grey	
							866 NOCE PAVIA STONE GREY pavia walnut stone grey	
SCRIVANIE DIREZIONALI CON ALLUNGO CONTENITORE executive desks with container extension   Fig.DX/right  L. x p.210 x H.75	DX right	L.160	155 <b>166</b> (*)	135	0,348	6	€ 559,00	
		L.180	155 <b>167</b> (*)	142	0,364	6	€ 571,00	
		L.200	155 <b>168</b> (*)	148	0,38	6	€ 592,00	
	SX left	L.160	155 <b>169</b> (*)	135	0,348	6	€ 559,00	
		L.180	155 <b>170</b> (*)	142	0,364	6	€ 571,00	
		L.200	155 <b>171</b> (*)	148	0,38	6	€ 592,00	
	 <b>COMPLETARE SEMPRE CON KIT CASSETTI ART.165</b> always complete with drawers kit art.165							
SET CASSETTI CON SERRATURA SUPERIORE PER ALLUNGO CONTENITORE drawers set with upper lock for container extension    L.43,8 x p.37,8 x H.24,2	(*)							
	166 NOCE PAVIA pavia walnut							
	440 BIANCO BR. br. white							
	551 ANTRACITE anthracite							
	633 AMARANTO amaranth							
		155 <b>165</b> (*)	7	0,062	1	€ 90,00	704 ROVERE GREY grey oak	
							733 ROVERE oak	
							844 STONE GREY stone grey	

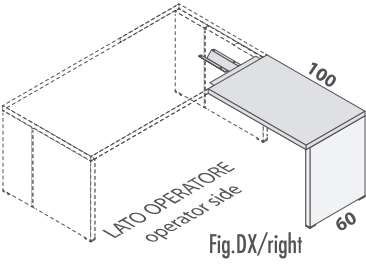
ALLUNGO extension							
DESCRIZIONE description	L w	CODICE code	KG	M <sup>3</sup>	COLLI	PREZZO price	(*) CODICE FINITURA (*) finish code
ALLUNGO LATERALE DX O SX right or left lateral extension    L.100 x p.60 x H.75	L.100	155 <b>172</b> (*)	33	0,071	3	€ 136,00	VERSIONE MONO-COLORE / single-color version
							(*)
							166 NOCE PAVIA pavia walnut
							440 BIANCO BR. br. white
							704 ROVERE GREY grey oak
							733 ROVERE oak
							VERSIONE BI-COLORE / double-color version
							(*) PIANO STRUTTURA top structure
							403 ROVERE BIANCO BR. oak br. white
							466 NOCE PAVIA BIANCO BR. pavia walnut br. white
							504 ROVERE GREY ANTRACITE grey oak anthracite
							566 NOCE PAVIA ANTRACITE pavia walnut anthracite
							803 ROVERE STONE GREY oak stone grey
							804 ROVERE GREY STONE GREY grey oak stone grey
							866 NOCE PAVIA STONE GREY pavia walnut stone grey

### CANALI PORTACAVI PER SCRIVANIE cable trays for desks

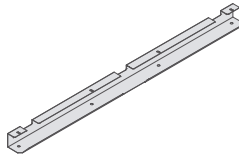
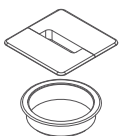
CANALI PORTACAVI sheet metal cable trays    L. x p.10,3 x H.7,6	L.108	175 <b>456</b> (*)	1,5	0,014	1	€ 25,00	(*)		
							450	BIANCO	white
	L.148	175 <b>458</b> (*)	1,8	0,021	1	€ 34,00	551	ANTRACITE	anthracite
							844	STONE GREY	stone grey
PASSACAVO Ø 80 mm cable-way Ø 80 mm  		175 <b>787</b> (*)	0,6	0,001	1	€ 23,00	(*)		
							450	BIANCO	white
							551	ANTRACITE	anthracite
							844	STONE GREY	stone grey

### SCHEMA DI UTILIZZO CANALI PORTACAVI scheme of use cable trays

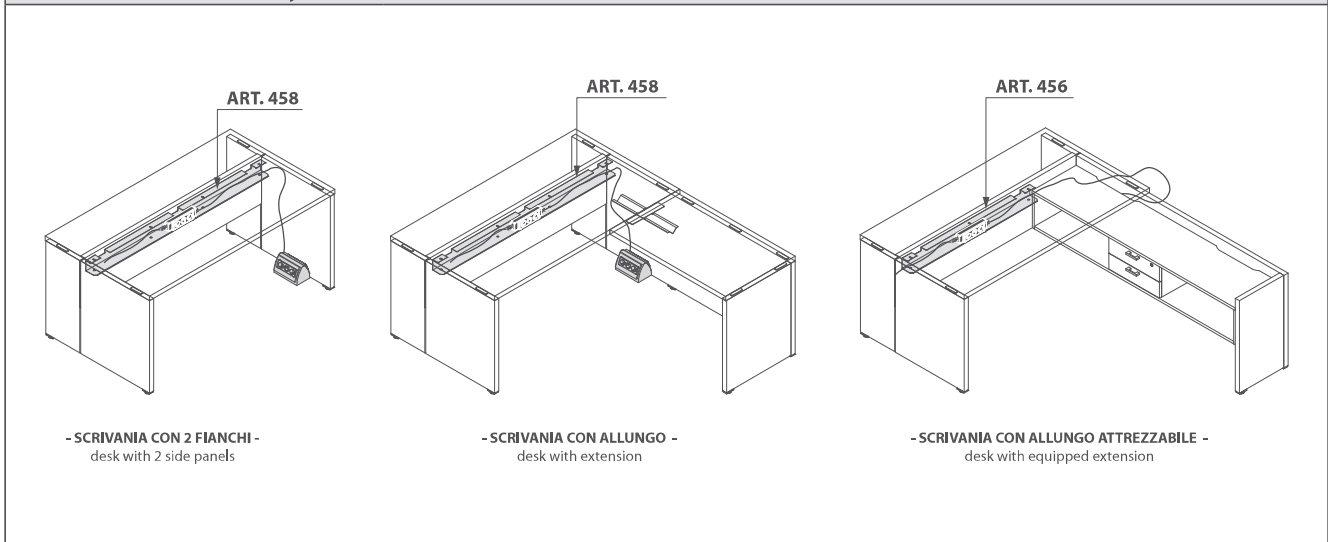

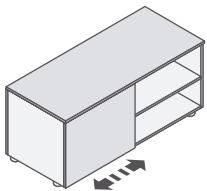
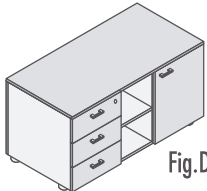
CASSETTIERE SU RUOTE mobile pedestals								
DESCRIZIONE description	L w	CODICE code	KG	M <sup>3</sup>	COLLI	PREZZO price	(*) CODICE FINITURA (*) finish code	
CASSETTIERA SU RUOTE 3 CASSETTI (CON SERRATURA) mobile pedestal with 3 drawers (with lock)    L.42,1 x p.55,2 x H.57,3								
	VERSIONE MONO-COLORE / single-color version							
	(*)							
	440	BIANCO BR.					br. white	
	VERSIONE BI-COLORE / double-color version							
	(*)							
			CASSETTI IN LEGNO wooden drawers			CON CHIUSURA AMMORTIZZATA with soft-close		
			155 780 (*)	24	0,152	1	€ 204,00	
								403 ROVERE BIANCO BR. oak br. white
								466 NOCE PAVIA BIANCO BR. pavia walnut br. white
							504 ROVERE GREY ANTRACITE grey oak anthracite	
							566 NOCE PAVIA ANTRACITE pavia walnut anthracite	
							803 ROVERE STONE GREY oak stone grey	
							804 ROVERE GREY STONE GREY grey oak stone grey	
							866 NOCE PAVIA STONE GREY pavia walnut stone grey	
<b>MOBILI DI SERVIZIO SU PIEDINI</b> <i>service units on adjustable feet</i>								
MOBILE DI SERVIZIO L.140 TERMINALE DX O SX CON ANTINA SCORREVOLE E VANO A GIORNO right or left terminal service unit w 140 cms with sliding door and open compartment    L.140 x p.60 x H.61,5								
			155 454 (*)	47	0,167	2	€ 264,00	
	VERSIONE MONO-COLORE / single-color version							
(*)								
440	BIANCO BR.						br. white	
VERSIONE BI-COLORE / double-color version								
(*)								
							403 ROVERE BIANCO BR. oak br. white	
							466 NOCE PAVIA BIANCO BR. pavia walnut br. white	
							504 ROVERE GREY ANTRACITE grey oak anthracite	
							566 NOCE PAVIA ANTRACITE pavia walnut anthracite	
							803 ROVERE STONE GREY oak stone grey	
							804 ROVERE GREY STONE GREY grey oak stone grey	
							866 NOCE PAVIA STONE GREY pavia walnut stone grey	
MOBILE DI SERVIZIO L.120 CON 3 CASSETTI, VANO A GIORNO E 1 ANTA CIEGA service unit w 120 cms with 3 drawers, open compartment and 1 wooden door   Fig.DX/right  L.120 x p.52,5 x H.61,5								
			CASSETTI IN LEGNO wooden drawers			CON CHIUSURA AMMORTIZZATA with soft-close		
	DX right		155 778 (*)	41	0,39	1	€ 347,00	
SX left		155 779 (*)						

**CONTROMOBILI e COMPLEMENTI**

*credenzas and complements*

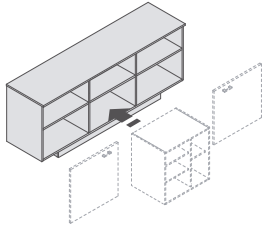
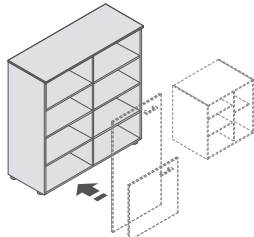
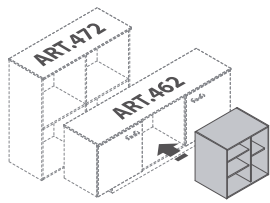
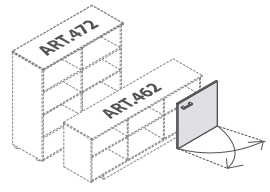
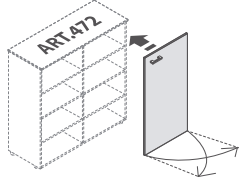
DESCRIZIONE <i>description</i>	L w	CODICE <i>code</i>	KG	M <sup>3</sup>	COLLI	PREZZO <i>price</i>	(*) CODICE FINITURA <i>(*) finish code</i>	
CONTROMOBILE L.180 <i>credenza w 180 cms</i>    L.179,5 x p.46,9 x H.72,6		155 462 (*)	81	0,196	5	€ 342,00		
	POSSIBILITÀ DI UTILIZZO ANTINE ED ELEMENTO LIBRERIA <i>possibility of use doors and bookcase element</i>							
								(*) 166 NOCE PAVIA <i>pavia walnut</i> 440 BIANCO BR. <i>br. white</i> 551 ANTRACITE <i>anthracite</i> 704 ROVERE GREY <i>grey oak</i> 733 ROVERE <i>oak</i> 844 STONE GREY <i>stone grey</i>
CONTROMOBILE L.120 <i>credenza w 120 cms</i>    L.120,4 x p.46,9 x H.123,6		155 472 (*)	80	0,19	5	€ 347,00		
	POSSIBILITÀ DI UTILIZZO ANTINE ED ELEMENTO LIBRERIA <i>possibility of use doors and bookcase element</i>							
ELEMENTO LIBRERIA PER CONTROMOBILI <i>bookcase element for credenzas</i>    L.57,2 x p.42,6 x H.57,2		155 473 (*)	12	0,183	1	€ 175,00		
	POSSIBILITÀ DI UTILIZZO ANTINE ED ELEMENTO LIBRERIA <i>possibility of use doors and bookcase element</i>							
								(*) 440 BIANCO BR. <i>br. white</i> 551 ANTRACITE <i>anthracite</i> 633 AMARANTO <i>amaranth</i> 844 STONE GREY <i>stone grey</i>
ANTINA BASSA DX O SX SENZA SERRATURA PER CONTROMOBILI ART.462-472 <i>right or left low wooden door without lock for ART.462-472</i>    L.57,2 x p.42,6 x H.57,2		155 476 (*)	6	0,02	1	€ 32,00		
	POSSIBILITÀ DI UTILIZZO ANTINE ED ELEMENTO LIBRERIA <i>possibility of use doors and bookcase element</i>							
								(*) 166 NOCE PAVIA <i>pavia walnut</i> 440 BIANCO BR. <i>br. white</i> 633 AMARANTO <i>amaranth</i> 704 ROVERE GREY <i>grey oak</i> 733 ROVERE <i>oak</i> 844 STONE GREY <i>stone grey</i>
ANTA MEDIA DX O SX SENZA SERRATURA PER CONTROMOBILE ART.472 <i>right or left medium wooden door without lock for ART.472</i>    L.57,2 x p.42,6 x H.57,2		155 477 (*)	12	0,035	1	€ 57,00		
	POSSIBILITÀ DI UTILIZZO ANTINE ED ELEMENTO LIBRERIA <i>possibility of use doors and bookcase element</i>							

**ESEMPI DI UTILIZZO COMPLEMENTI PER CONTROMOBILE**

*examples of use the complements for credenza*



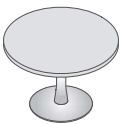
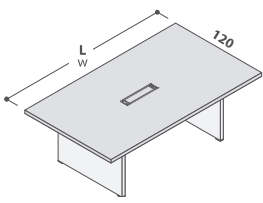

TAVOLI RIUNIONE meeting tables																																																																																																																																																													
DESCRIZIONE description	L w	CODICE code	KG	M <sup>3</sup>	COLLI	PREZZO price	(*) CODICE FINITURA (*) finish code																																																																																																																																																						
TAVOLO RIUNIONE CIRCOLARE rounded meeting table    Ø 120 x H.72,8	<table border="1"> <tr> <td colspan="2"></td> <td colspan="2"></td> <td colspan="2"></td> <td colspan="2"></td> </tr> <tr> <td colspan="2"></td> <td colspan="2"></td> <td colspan="2"></td> <td colspan="2"></td> </tr> <tr> <td colspan="2"></td> <td colspan="2"></td> <td colspan="2"></td> <td colspan="2"></td> </tr> <tr> <td colspan="2"></td> <td colspan="2"></td> <td colspan="2"></td> <td colspan="2"></td> </tr> <tr> <td colspan="2"></td> <td colspan="2"></td> <td colspan="2"></td> <td colspan="2"></td> </tr> <tr> <td colspan="2"></td> <td colspan="2"></td> <td colspan="2"></td> <td colspan="2"></td> </tr> <tr> <td colspan="2"></td> <td colspan="2"></td> <td colspan="2"></td> <td colspan="2"></td> </tr> <tr> <td colspan="2"></td> <td colspan="2"></td> <td colspan="2"></td> <td colspan="2"></td> </tr> <tr> <td colspan="2"></td> <td colspan="2"></td> <td colspan="2"></td> <td colspan="2"></td> </tr> <tr> <td colspan="2"></td> <td colspan="2"></td> <td colspan="2"></td> <td colspan="2"></td> </tr> </table>																																																																																	<table border="1"> <tr> <th>(*)</th> <th>PIANO</th> <th>BASAMENTO</th> <th>top</th> <th>basement</th> </tr> <tr> <td>403</td> <td>ROVERE</td> <td>BIANCO BR.</td> <td>oak</td> <td>br. white</td> </tr> <tr> <td>440</td> <td>BIANCO BR.</td> <td>BIANCO BR.</td> <td>br. white</td> <td>br. white</td> </tr> <tr> <td>466</td> <td>NOCE PAVIA</td> <td>BIANCO BR.</td> <td>pavia walnut</td> <td>br. white</td> </tr> <tr> <td>504</td> <td>ROVERE GREY</td> <td>ANTRACITE</td> <td>grey oak</td> <td>anthracite</td> </tr> <tr> <td>566</td> <td>NOCE PAVIA</td> <td>ANTRACITE</td> <td>pavia walnut</td> <td>anthracite</td> </tr> <tr> <td>803</td> <td>ROVERE</td> <td>STONE GREY</td> <td>oak</td> <td>stone grey</td> </tr> <tr> <td>804</td> <td>ROVERE GREY</td> <td>STONE GREY</td> <td>grey oak</td> <td>stone grey</td> </tr> <tr> <td>866</td> <td>NOCE PAVIA</td> <td>STONE GREY</td> <td>pavia walnut</td> <td>stone grey</td> </tr> </table>	(*)	PIANO	BASAMENTO	top	basement	403	ROVERE	BIANCO BR.	oak	br. white	440	BIANCO BR.	BIANCO BR.	br. white	br. white	466	NOCE PAVIA	BIANCO BR.	pavia walnut	br. white	504	ROVERE GREY	ANTRACITE	grey oak	anthracite	566	NOCE PAVIA	ANTRACITE	pavia walnut	anthracite	803	ROVERE	STONE GREY	oak	stone grey	804	ROVERE GREY	STONE GREY	grey oak	stone grey	866	NOCE PAVIA	STONE GREY	pavia walnut	stone grey																														
(*)	PIANO	BASAMENTO	top	basement																																																																																																																																																									
403	ROVERE	BIANCO BR.	oak	br. white																																																																																																																																																									
440	BIANCO BR.	BIANCO BR.	br. white	br. white																																																																																																																																																									
466	NOCE PAVIA	BIANCO BR.	pavia walnut	br. white																																																																																																																																																									
504	ROVERE GREY	ANTRACITE	grey oak	anthracite																																																																																																																																																									
566	NOCE PAVIA	ANTRACITE	pavia walnut	anthracite																																																																																																																																																									
803	ROVERE	STONE GREY	oak	stone grey																																																																																																																																																									
804	ROVERE GREY	STONE GREY	grey oak	stone grey																																																																																																																																																									
866	NOCE PAVIA	STONE GREY	pavia walnut	stone grey																																																																																																																																																									
Ø120	155	091 (*)	59	0,175	3	€ 415,00																																																																																																																																																							
TAVOLO RIUNIONE RETTANGOLARE rectangular meeting table    L. x p.120 x H.75	<table border="1"> <tr> <td colspan="2"></td> <td colspan="2"></td> <td colspan="2"></td> <td colspan="2"></td> </tr> <tr> <td colspan="2"></td> <td colspan="2"></td> <td colspan="2"></td> <td colspan="2"></td> </tr> <tr> <td colspan="2"></td> <td colspan="2"></td> <td colspan="2"></td> <td colspan="2"></td> </tr> <tr> <td colspan="2"></td> <td colspan="2"></td> <td colspan="2"></td> <td colspan="2"></td> </tr> <tr> <td colspan="2"></td> <td colspan="2"></td> <td colspan="2"></td> <td colspan="2"></td> </tr> <tr> <td colspan="2"></td> <td colspan="2"></td> <td colspan="2"></td> <td colspan="2"></td> </tr> <tr> <td colspan="2"></td> <td colspan="2"></td> <td colspan="2"></td> <td colspan="2"></td> </tr> <tr> <td colspan="2"></td> <td colspan="2"></td> <td colspan="2"></td> <td colspan="2"></td> </tr> <tr> <td colspan="2"></td> <td colspan="2"></td> <td colspan="2"></td> <td colspan="2"></td> </tr> <tr> <td colspan="2"></td> <td colspan="2"></td> <td colspan="2"></td> <td colspan="2"></td> </tr> </table>																																																																																	<table border="1"> <tr> <th colspan="5">VERSIONE MONO-COLORE / single-color version</th> </tr> <tr> <th>(*)</th> <th>PIANO</th> <th>STRUTTURA</th> <th>top</th> <th>structure</th> </tr> <tr> <td>166</td> <td>NOCE PAVIA</td> <td></td> <td>pavia walnut</td> <td></td> </tr> <tr> <td>440</td> <td>BIANCO BR.</td> <td></td> <td>br. white</td> <td></td> </tr> <tr> <td>704</td> <td>ROVERE GREY</td> <td></td> <td>grey oak</td> <td></td> </tr> <tr> <td>733</td> <td>ROVERE</td> <td></td> <td>oak</td> <td></td> </tr> <tr> <th colspan="5">VERSIONE BI-COLORE / double-color version</th> </tr> <tr> <th>(*)</th> <th>PIANO</th> <th>STRUTTURA</th> <th>top</th> <th>structure</th> </tr> <tr> <td>403</td> <td>ROVERE</td> <td>BIANCO BR.</td> <td>oak</td> <td>br. white</td> </tr> <tr> <td>466</td> <td>NOCE PAVIA</td> <td>BIANCO BR.</td> <td>pavia walnut</td> <td>br. white</td> </tr> <tr> <td>504</td> <td>ROVERE GREY</td> <td>ANTRACITE</td> <td>grey oak</td> <td>anthracite</td> </tr> <tr> <td>566</td> <td>NOCE PAVIA</td> <td>ANTRACITE</td> <td>pavia walnut</td> <td>anthracite</td> </tr> <tr> <td>803</td> <td>ROVERE</td> <td>STONE GREY</td> <td>oak</td> <td>stone grey</td> </tr> <tr> <td>804</td> <td>ROVERE GREY</td> <td>STONE GREY</td> <td>grey oak</td> <td>stone grey</td> </tr> <tr> <td>866</td> <td>NOCE PAVIA</td> <td>STONE GREY</td> <td>pavia walnut</td> <td>stone grey</td> </tr> </table>	VERSIONE MONO-COLORE / single-color version					(*)	PIANO	STRUTTURA	top	structure	166	NOCE PAVIA		pavia walnut		440	BIANCO BR.		br. white		704	ROVERE GREY		grey oak		733	ROVERE		oak		VERSIONE BI-COLORE / double-color version					(*)	PIANO	STRUTTURA	top	structure	403	ROVERE	BIANCO BR.	oak	br. white	466	NOCE PAVIA	BIANCO BR.	pavia walnut	br. white	504	ROVERE GREY	ANTRACITE	grey oak	anthracite	566	NOCE PAVIA	ANTRACITE	pavia walnut	anthracite	803	ROVERE	STONE GREY	oak	stone grey	804	ROVERE GREY	STONE GREY	grey oak	stone grey	866	NOCE PAVIA	STONE GREY	pavia walnut	stone grey
VERSIONE MONO-COLORE / single-color version																																																																																																																																																													
(*)	PIANO	STRUTTURA	top	structure																																																																																																																																																									
166	NOCE PAVIA		pavia walnut																																																																																																																																																										
440	BIANCO BR.		br. white																																																																																																																																																										
704	ROVERE GREY		grey oak																																																																																																																																																										
733	ROVERE		oak																																																																																																																																																										
VERSIONE BI-COLORE / double-color version																																																																																																																																																													
(*)	PIANO	STRUTTURA	top	structure																																																																																																																																																									
403	ROVERE	BIANCO BR.	oak	br. white																																																																																																																																																									
466	NOCE PAVIA	BIANCO BR.	pavia walnut	br. white																																																																																																																																																									
504	ROVERE GREY	ANTRACITE	grey oak	anthracite																																																																																																																																																									
566	NOCE PAVIA	ANTRACITE	pavia walnut	anthracite																																																																																																																																																									
803	ROVERE	STONE GREY	oak	stone grey																																																																																																																																																									
804	ROVERE GREY	STONE GREY	grey oak	stone grey																																																																																																																																																									
866	NOCE PAVIA	STONE GREY	pavia walnut	stone grey																																																																																																																																																									
L.210	155	240 (*)	110	0,256	3	€ 460,00																																																																																																																																																							
L.260	155	252 (*)	124	0,306	3	€ 538,00																																																																																																																																																							
L.210	155	242 (*)	110	0,256	3	€ 506,00																																																																																																																																																							
L.260	155	253 (*)	124	0,306	3	€ 587,00																																																																																																																																																							

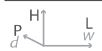

**SCHEMA DI UTILIZZO MOBILI CONTENITORI**

*scheme of using cabinets*



**TUTTE LE COMPOSIZIONI CON I MOBILI CONTENITORI DEVONO ESSERE COMPLETATE CON TOP + 2 FIANCHI FINALI (vedi pag.15)**  
*always complete the compositions with top + 2 final side-panels (please see page 15)*

ESEMPIO / *example*

**TOP + 2 FIANCHI FINALI**



*top + 2 final side panels*

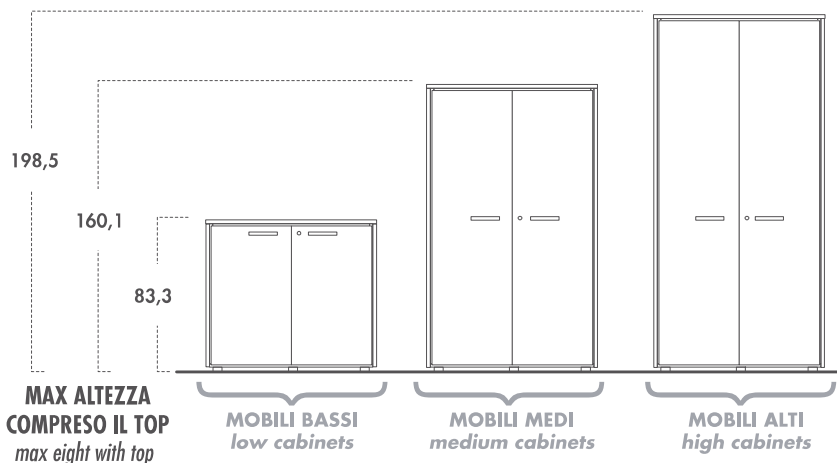
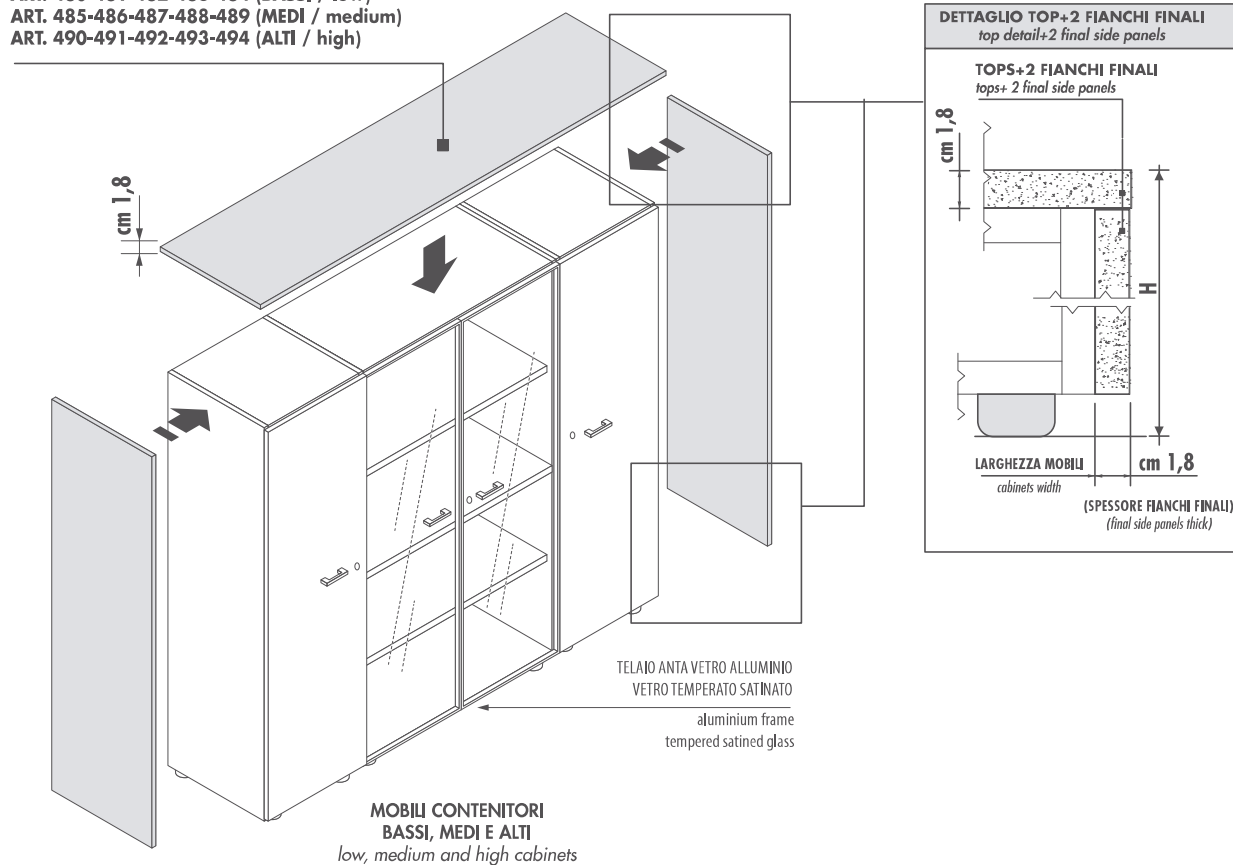

ART. 480-481-482-483-484 (BASSI / *low*)

ART. 485-486-487-488-489 (MEDI / *medium*)

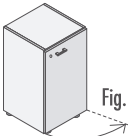
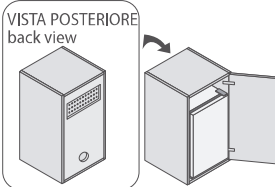
ART. 490-491-492-493-494 (ALTI / *high*)

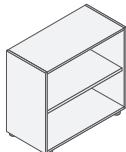
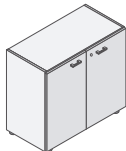

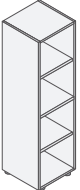

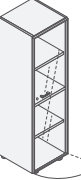
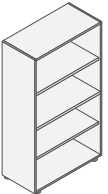
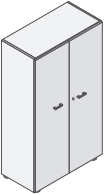
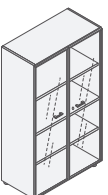

MOBILI BASSI low cabinets		TUTTE LE COMPOSIZIONI CON I MOBILI CONTENITORI DEVONO ESSERE COMPLETATE CON TOP + 2 FIANCHI FINALI (VEDI PAG. 15) always complete the compositions with top + 2 final side panels (please see page 15)						(*) CODICE FINITURA (*) finish code																																																	
DESCRIZIONE description	L w	CODICE code	KG	M <sup>3</sup>	COLLI	PREZZO price																																																			
MOBILE BASSO A GIORNO L.45 open low cabinet w 45 cms    L.45 x p.44,5 x H.81,5							<table border="1"> <thead> <tr> <th>(*)</th> <th>STRUTTURA</th> <th>structure</th> </tr> </thead> <tbody> <tr> <td>166</td> <td>NOCE PAVIA</td> <td>pavia walnut</td> </tr> <tr> <td>440</td> <td>BIANCO BR.</td> <td>br. white</td> </tr> <tr> <td>551</td> <td>ANTRACITE</td> <td>anthracite</td> </tr> <tr> <td>844</td> <td>STONE GREY</td> <td>stone grey</td> </tr> </tbody> </table>		(*)	STRUTTURA	structure	166	NOCE PAVIA	pavia walnut	440	BIANCO BR.	br. white	551	ANTRACITE	anthracite	844	STONE GREY	stone grey																																		
	(*)	STRUTTURA	structure																																																						
166	NOCE PAVIA	pavia walnut																																																							
440	BIANCO BR.	br. white																																																							
551	ANTRACITE	anthracite																																																							
844	STONE GREY	stone grey																																																							
L.45	155 800 (*)	20	0,047	2	€ 77,00																																																				
MOBILE BASSO L.45 CON 1 ANTA LEGNO CON SERRATURA low cabinet w 45 cms with 1 wooden door with lock   Fig.DX/right  L.45 x p.46,3 x H.81,5	DX right	L.45	155 803 (*)	25	0,069	3	€ 108,00																																																		
	SX left	L.45	155 804 (*)																																																						
MOBILE BASSO L.45 CON 1 ANTA LEGNO DX CON SERRATURA, COMPLETO DI FRIGORIFERO DA LT. 38+ GRIGLIA DI AERAZIONE low cabinet w 45 cms with right wooden door with lock, and refrigerator 38 liters+airing grid   VISTA POSTERIORE back view  L.45 x p.46,3 x H.81,5							VERSIONE MONO-COLORE / single-color version <table border="1"> <thead> <tr> <th>(*)</th> <th></th> <th></th> </tr> </thead> <tbody> <tr> <td>166</td> <td>NOCE PAVIA</td> <td>pavia walnut</td> </tr> <tr> <td>440</td> <td>BIANCO BR.</td> <td>br. white</td> </tr> </tbody> </table> VERSIONE BI-COLORE / double-color version <table border="1"> <thead> <tr> <th>(*)</th> <th>FRONTALI</th> <th>STRUTTURA</th> <th>fronts</th> <th>structure</th> </tr> </thead> <tbody> <tr> <td>403</td> <td>ROVERE</td> <td>BIANCO BR.</td> <td>oak</td> <td>br. white</td> </tr> <tr> <td>466</td> <td>NOCE PAVIA</td> <td>BIANCO BR.</td> <td>pavia walnut</td> <td>br. white</td> </tr> <tr> <td>504</td> <td>ROVERE GREY</td> <td>ANTRACITE</td> <td>grey oak</td> <td>anthracite</td> </tr> <tr> <td>566</td> <td>NOCE PAVIA</td> <td>ANTRACITE</td> <td>pavia walnut</td> <td>anthracite</td> </tr> <tr> <td>803</td> <td>ROVERE</td> <td>STONE GREY</td> <td>oak</td> <td>stone grey</td> </tr> <tr> <td>804</td> <td>ROVERE GREY</td> <td>STONE GREY</td> <td>grey oak</td> <td>stone grey</td> </tr> <tr> <td>866</td> <td>NOCE PAVIA</td> <td>STONE GREY</td> <td>pavia walnut</td> <td>stone grey</td> </tr> </tbody> </table>		(*)			166	NOCE PAVIA	pavia walnut	440	BIANCO BR.	br. white	(*)	FRONTALI	STRUTTURA	fronts	structure	403	ROVERE	BIANCO BR.	oak	br. white	466	NOCE PAVIA	BIANCO BR.	pavia walnut	br. white	504	ROVERE GREY	ANTRACITE	grey oak	anthracite	566	NOCE PAVIA	ANTRACITE	pavia walnut	anthracite	803	ROVERE	STONE GREY	oak	stone grey	804	ROVERE GREY	STONE GREY	grey oak	stone grey	866	NOCE PAVIA	STONE GREY	pavia walnut	stone grey
	(*)																																																								
166	NOCE PAVIA	pavia walnut																																																							
440	BIANCO BR.	br. white																																																							
(*)	FRONTALI	STRUTTURA	fronts	structure																																																					
403	ROVERE	BIANCO BR.	oak	br. white																																																					
466	NOCE PAVIA	BIANCO BR.	pavia walnut	br. white																																																					
504	ROVERE GREY	ANTRACITE	grey oak	anthracite																																																					
566	NOCE PAVIA	ANTRACITE	pavia walnut	anthracite																																																					
803	ROVERE	STONE GREY	oak	stone grey																																																					
804	ROVERE GREY	STONE GREY	grey oak	stone grey																																																					
866	NOCE PAVIA	STONE GREY	pavia walnut	stone grey																																																					
DX right	L.45	155 809 (*)	44	0,183	4	€ 920,00	DIMENSIONI FRIGORIFERO: L.39 x p.40 x H.54,2 dimensions of refrigerator: w 39 x d 40 x h 54,2 cms																																																		
MOBILE BASSO L.45 CON 4 CASSETTI SENZA SERRATURA low cabinet w 45 cms with 4 drawers without lock    L.45 x p.46,3 x H.81,5			CASSETTI IN LEGNO wooden drawers	CON CHIUSURA AMMORTIZZATA with soft-close																																																					
	L.45	155 597 (*)	33	0,23	1	€ 188,00																																																			
MOBILE BASSO A GIORNO L.90 open low cabinet w 90 cms    L.90 x p.44,5 x H.81,5							<table border="1"> <thead> <tr> <th>(*)</th> <th>STRUTTURA</th> <th>structure</th> </tr> </thead> <tbody> <tr> <td>166</td> <td>NOCE PAVIA</td> <td>pavia walnut</td> </tr> <tr> <td>440</td> <td>BIANCO BR.</td> <td>br. white</td> </tr> <tr> <td>551</td> <td>ANTRACITE</td> <td>anthracite</td> </tr> <tr> <td>844</td> <td>STONE GREY</td> <td>stone grey</td> </tr> </tbody> </table>		(*)	STRUTTURA	structure	166	NOCE PAVIA	pavia walnut	440	BIANCO BR.	br. white	551	ANTRACITE	anthracite	844	STONE GREY	stone grey																																		
	(*)	STRUTTURA	structure																																																						
166	NOCE PAVIA	pavia walnut																																																							
440	BIANCO BR.	br. white																																																							
551	ANTRACITE	anthracite																																																							
844	STONE GREY	stone grey																																																							
L.90	155 810 (*)	31	0,072	2	€ 113,00																																																				
MOBILE BASSO L.90 CON 2 ANTE LEGNO CON SERRATURA low cabinet w 90 cms with 2 wooden doors with lock    L.90 x p.46,3 x H.81,5							VERSIONE MONO-COLORE / single-color version <table border="1"> <thead> <tr> <th>(*)</th> <th></th> <th></th> </tr> </thead> <tbody> <tr> <td>166</td> <td>NOCE PAVIA</td> <td>pavia walnut</td> </tr> <tr> <td>440</td> <td>BIANCO BR.</td> <td>br. white</td> </tr> </tbody> </table> VERSIONE BI-COLORE / double-color version <table border="1"> <thead> <tr> <th>(*)</th> <th>ANTE</th> <th>STRUTTURA</th> <th>doors</th> <th>structure</th> </tr> </thead> <tbody> <tr> <td>403</td> <td>ROVERE</td> <td>BIANCO BR.</td> <td>oak</td> <td>br. white</td> </tr> <tr> <td>466</td> <td>NOCE PAVIA</td> <td>BIANCO BR.</td> <td>pavia walnut</td> <td>br. white</td> </tr> <tr> <td>504</td> <td>ROVERE GREY</td> <td>ANTRACITE</td> <td>grey oak</td> <td>anthracite</td> </tr> <tr> <td>566</td> <td>NOCE PAVIA</td> <td>ANTRACITE</td> <td>pavia walnut</td> <td>anthracite</td> </tr> <tr> <td>803</td> <td>ROVERE</td> <td>STONE GREY</td> <td>oak</td> <td>stone grey</td> </tr> <tr> <td>804</td> <td>ROVERE GREY</td> <td>STONE GREY</td> <td>grey oak</td> <td>stone grey</td> </tr> <tr> <td>866</td> <td>NOCE PAVIA</td> <td>STONE GREY</td> <td>pavia walnut</td> <td>stone grey</td> </tr> </tbody> </table>		(*)			166	NOCE PAVIA	pavia walnut	440	BIANCO BR.	br. white	(*)	ANTE	STRUTTURA	doors	structure	403	ROVERE	BIANCO BR.	oak	br. white	466	NOCE PAVIA	BIANCO BR.	pavia walnut	br. white	504	ROVERE GREY	ANTRACITE	grey oak	anthracite	566	NOCE PAVIA	ANTRACITE	pavia walnut	anthracite	803	ROVERE	STONE GREY	oak	stone grey	804	ROVERE GREY	STONE GREY	grey oak	stone grey	866	NOCE PAVIA	STONE GREY	pavia walnut	stone grey
	(*)																																																								
166	NOCE PAVIA	pavia walnut																																																							
440	BIANCO BR.	br. white																																																							
(*)	ANTE	STRUTTURA	doors	structure																																																					
403	ROVERE	BIANCO BR.	oak	br. white																																																					
466	NOCE PAVIA	BIANCO BR.	pavia walnut	br. white																																																					
504	ROVERE GREY	ANTRACITE	grey oak	anthracite																																																					
566	NOCE PAVIA	ANTRACITE	pavia walnut	anthracite																																																					
803	ROVERE	STONE GREY	oak	stone grey																																																					
804	ROVERE GREY	STONE GREY	grey oak	stone grey																																																					
866	NOCE PAVIA	STONE GREY	pavia walnut	stone grey																																																					
L.90	155 807 (*)	41	0,105	3	€ 165,00																																																				

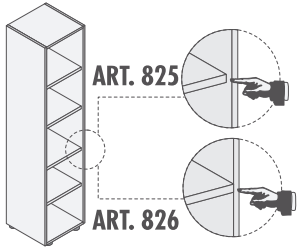
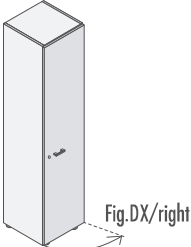
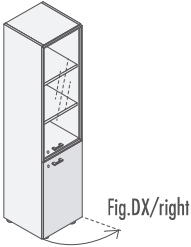
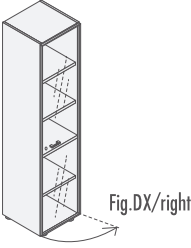
MOBILI MEDI medium cabinets		TUTTE LE COMPOSIZIONI CON I MOBILI CONTENITORI DEVONO ESSERE COMPLETATE CON TOP + 2 FIANCHI FINALI (VEDI PAG. 15) always complete the compositions with top + 2 final side panels (please see page 15)					PREZZO price		(*) CODICE FINITURA (*) finish code		
DESCRIZIONE description	L w	CODICE code	KG	M <sup>3</sup>	COLLI						
MOBILE MEDIO A GIORNO L.45 open medium cabinet w 45 cms  L.45 x p.44,5 x H.158,3	L.45	155 <b>815</b> (*)	36	0,088	3	€ 138,00	(*)		STRUTTURA structure		
							166	NOCE PAVIA	pavia walnut	440	BIANCO BR.
MOBILE MEDIO L.45 CON 1 ANTA LEGNO CON SERRATURA medium cabinet w 45 cms with 1 wooden door with lock  Fig.DX/right L.45 x p.46,3 x H.158,3	L.45	155 <b>860</b> (*)	46	0,131	4	€ 191,00	VERSIONE MONO-COLORE / single-color version				
							(*)		STRUTTURA structure		
		166	NOCE PAVIA	pavia walnut	440	BIANCO BR.	br. white				
		VERSIONE BI-COLORE / double-color version				(*)		ANTE	STRUTTURA	doors	structure
		403	ROVERE	BIANCO BR.	oak	br. white	466	NOCE PAVIA	BIANCO BR.	pavia walnut	br. white
		504	ROVERE GREY	ANTRACITE	grey oak	anthracite	566	NOCE PAVIA	ANTRACITE	pavia walnut	anthracite
		803	ROVERE	STONE GREY	oak	stone grey	804	ROVERE GREY	STONE GREY	grey oak	stone grey
		866	NOCE PAVIA	STONE GREY	pavia walnut	stone grey					
MOBILE MEDIO L.45 CON 1 ANTA VETRO CON SERRATURA medium cabinet w 45 cms with 1 glass door with lock  Fig.DX/right L.45 x p.46,3 x H.158,3	L.45	155 <b>862</b> (*)	48	0,13	5	€ 272,00	MOBILI FORNITI CON ANTA: TELAIO ALLUMINIO E VETRO TEMPERATO SATINATO supplied cabinets with door: aluminium frame and tempered satined glass				
							(*)		STRUTTURA structure		
		166	NOCE PAVIA	pavia walnut	440	BIANCO BR.	br. white				
		551	ANTRACITE	anthracite	844	STONE GREY	stone grey				
MOBILE MEDIO A GIORNO L.90 open medium cabinet w 90 cms  L.90 x p.44,5 x H.158,3	L.90	155 <b>820</b> (*)	57	0,135	3	€ 205,00					
							(*)		STRUTTURA structure		
		166	NOCE PAVIA	pavia walnut	440	BIANCO BR.	br. white				
		551	ANTRACITE	anthracite	844	STONE GREY	stone grey				
MOBILE MEDIO L.90 CON 2 ANTE LEGNO CON SERRATURA medium cabinet w 90 cms with 2 wooden doors with lock  L.90 x p.46,3 x H.158,3	L.90	155 <b>869</b> (*)	77	0,199	4	€ 290,00	VERSIONE MONO-COLORE / single-color version				
							(*)		STRUTTURA structure		
		166	NOCE PAVIA	pavia walnut	440	BIANCO BR.	br. white				
		VERSIONE BI-COLORE / double-color version				(*)		ANTE	STRUTTURA	doors	structure
		403	ROVERE	BIANCO BR.	oak	br. white	466	NOCE PAVIA	BIANCO BR.	pavia walnut	br. white
		504	ROVERE GREY	ANTRACITE	grey oak	anthracite	566	NOCE PAVIA	ANTRACITE	pavia walnut	anthracite
		803	ROVERE	STONE GREY	oak	stone grey	804	ROVERE GREY	STONE GREY	grey oak	stone grey
		866	NOCE PAVIA	STONE GREY	pavia walnut	stone grey					
MOBILE MEDIO L.90 CON 2 ANTE VETRO CON SERRATURA medium cabinet w 90 cms with 2 glass doors with lock  L.90 x p.46,3 x H.158,3	L.90	155 <b>874</b> (*)	80	0,218	6	€ 470,00	MOBILI FORNITI CON ANTE: TELAIO ALLUMINIO E VETRO TEMPERATO SATINATO supplied cabinets with doors: aluminium frame and tempered satined glass				
							(*)		STRUTTURA structure		
		166	NOCE PAVIA	pavia walnut	440	BIANCO BR.	br. white				
		551	ANTRACITE	anthracite	844	STONE GREY	stone grey				

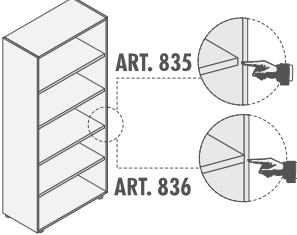
**MOBILI ALTI**  
*high cabinets*
**TUTTE LE COMPOSIZIONI CON I MOBILI CONTENITORI DEVONO ESSERE COMPLETATE CON TOP + 2 FIANCHI FINALI (VEDI PAG. 15)**  
*always complete the compositions with top + 2 final side panels (please see page 15)*

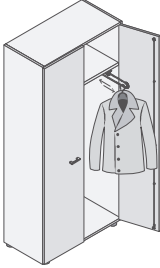
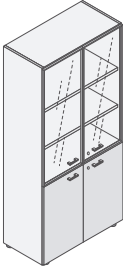
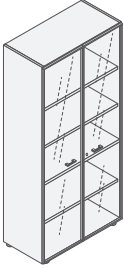
DESCRIZIONE <i>description</i>	L <i>w</i>	CODICE <i>code</i>	KG	M <sup>3</sup>	COLLI	PREZZO <i>price</i>	(*) CODICE FINITURA <i>(*) finish code</i>																																								
MOBILE ALTO A GIORNO L.45 <i>open high cabinet w 45 cms</i>    L.45 x p.44,5 x H.196,7	<b>CARCASSA PER ANTE INTERE SOLO LEGNO</b> <i>structure for whole wooden doors only</i>						<table border="1"> <thead> <tr> <th>(*)</th> <th>STRUTTURA</th> <th><i>structure</i></th> </tr> </thead> <tbody> <tr> <td>166</td> <td>NOCE PAVIA</td> <td><i>pavia walnut</i></td> </tr> <tr> <td>440</td> <td>BIANCO BR.</td> <td><i>br. white</i></td> </tr> </tbody> </table>	(*)	STRUTTURA	<i>structure</i>	166	NOCE PAVIA	<i>pavia walnut</i>	440	BIANCO BR.	<i>br. white</i>																															
	(*)	STRUTTURA	<i>structure</i>																																												
	166	NOCE PAVIA	<i>pavia walnut</i>																																												
	440	BIANCO BR.	<i>br. white</i>																																												
	L.45	155 <b>825 (*)</b>	49	0,104	3	€ 166,00	<table border="1"> <thead> <tr> <th>(*)</th> <th>STRUTTURA</th> <th><i>structure</i></th> </tr> </thead> <tbody> <tr> <td>551</td> <td>ANTRACITE</td> <td><i>anthracite</i></td> </tr> <tr> <td>844</td> <td>STONE GREY</td> <td><i>stone grey</i></td> </tr> </tbody> </table>	(*)	STRUTTURA	<i>structure</i>	551	ANTRACITE	<i>anthracite</i>	844	STONE GREY	<i>stone grey</i>																															
(*)	STRUTTURA	<i>structure</i>																																													
551	ANTRACITE	<i>anthracite</i>																																													
844	STONE GREY	<i>stone grey</i>																																													
<b>CARCASSA PER ANTE SPEZZATE LEGNO E TUTTE LE TIPOLOGIE DI ANTE VETRO</b> <i>structure for split wooden doors and all types glass doors</i>																																															
L.45	155 <b>826 (*)</b>	49	0,104	3	€ 166,00																																										
MOBILE ALTO L.45 CON 1 ANTA LEGNO CON SERRATURA <i>high cabinet w 45 cms with 1 wooden door with lock</i>    L.45 x p.46,3 x H.196,7	DX <i>right</i>	L.45	155 <b>885 (*)</b>	61	0,171	4	€ 245,00																																								
	SX <i>left</i>	L.45	155 <b>886 (*)</b>																																												
	VERSIONE MONO-COLORE / <i>single-color version</i>							<table border="1"> <thead> <tr> <th>(*)</th> <th>STRUTTURA</th> <th><i>structure</i></th> </tr> </thead> <tbody> <tr> <td>166</td> <td>NOCE PAVIA</td> <td><i>pavia walnut</i></td> </tr> <tr> <td>440</td> <td>BIANCO BR.</td> <td><i>br. white</i></td> </tr> </tbody> </table>	(*)	STRUTTURA	<i>structure</i>	166	NOCE PAVIA	<i>pavia walnut</i>	440	BIANCO BR.	<i>br. white</i>																														
	(*)	STRUTTURA	<i>structure</i>																																												
	166	NOCE PAVIA	<i>pavia walnut</i>																																												
440	BIANCO BR.	<i>br. white</i>																																													
VERSIONE BI-COLORE / <i>double-color version</i>							<table border="1"> <thead> <tr> <th>(*)</th> <th>ANTE</th> <th>STRUTTURA</th> <th><i>doors</i></th> <th><i>structure</i></th> </tr> </thead> <tbody> <tr> <td>403</td> <td>ROVERE</td> <td>BIANCO BR.</td> <td><i>oak</i></td> <td><i>br. white</i></td> </tr> <tr> <td>466</td> <td>NOCE PAVIA</td> <td>BIANCO BR.</td> <td><i>pavia walnut</i></td> <td><i>br. white</i></td> </tr> <tr> <td>504</td> <td>ROVERE GREY</td> <td>ANTRACITE</td> <td><i>grey oak</i></td> <td><i>anthracite</i></td> </tr> <tr> <td>566</td> <td>NOCE PAVIA</td> <td>ANTRACITE</td> <td><i>pavia walnut</i></td> <td><i>anthracite</i></td> </tr> <tr> <td>803</td> <td>ROVERE</td> <td>STONE GREY</td> <td><i>oak</i></td> <td><i>stone grey</i></td> </tr> <tr> <td>804</td> <td>ROVERE GREY</td> <td>STONE GREY</td> <td><i>grey oak</i></td> <td><i>stone grey</i></td> </tr> <tr> <td>866</td> <td>NOCE PAVIA</td> <td>STONE GREY</td> <td><i>pavia walnut</i></td> <td><i>stone grey</i></td> </tr> </tbody> </table>	(*)	ANTE	STRUTTURA	<i>doors</i>	<i>structure</i>	403	ROVERE	BIANCO BR.	<i>oak</i>	<i>br. white</i>	466	NOCE PAVIA	BIANCO BR.	<i>pavia walnut</i>	<i>br. white</i>	504	ROVERE GREY	ANTRACITE	<i>grey oak</i>	<i>anthracite</i>	566	NOCE PAVIA	ANTRACITE	<i>pavia walnut</i>	<i>anthracite</i>	803	ROVERE	STONE GREY	<i>oak</i>	<i>stone grey</i>	804	ROVERE GREY	STONE GREY	<i>grey oak</i>	<i>stone grey</i>	866	NOCE PAVIA	STONE GREY	<i>pavia walnut</i>	<i>stone grey</i>
(*)	ANTE	STRUTTURA	<i>doors</i>	<i>structure</i>																																											
403	ROVERE	BIANCO BR.	<i>oak</i>	<i>br. white</i>																																											
466	NOCE PAVIA	BIANCO BR.	<i>pavia walnut</i>	<i>br. white</i>																																											
504	ROVERE GREY	ANTRACITE	<i>grey oak</i>	<i>anthracite</i>																																											
566	NOCE PAVIA	ANTRACITE	<i>pavia walnut</i>	<i>anthracite</i>																																											
803	ROVERE	STONE GREY	<i>oak</i>	<i>stone grey</i>																																											
804	ROVERE GREY	STONE GREY	<i>grey oak</i>	<i>stone grey</i>																																											
866	NOCE PAVIA	STONE GREY	<i>pavia walnut</i>	<i>stone grey</i>																																											
MOBILE ALTO L.45 CON 1 ANTA BASSA LEGNO E 1 ANTA VETRO CON SERRATURE <i>high cabinet w 45 cms with 1 low wooden door and 1 glass door with locks</i>    L.45 x p.46,3 x H.196,7	DX <i>right</i>	L.45	155 <b>879 (*)</b>	63	0,16	6	€ 304,00																																								
	SX <i>left</i>	L.45	155 <b>880 (*)</b>																																												
	MOBILE FORNITO CON ANTA: <b>TELAIO ALLUMINIO E VETRO TEMPERATO SATINATO</b> <i>supplied cabinet with door: aluminium frame and tempered satined glass</i>																																														
	MOBILE ALTO L.45 CON 1 ANTA VETRO CON SERRATURA <i>high cabinet w 45 cms with 1 glass door with lock</i>    L.45 x p.46,3 x H.196,7	DX <i>right</i>	L.45	155 <b>887 (*)</b>	64	0,156	5	€ 313,00																																							
		SX <i>left</i>	L.45	155 <b>888 (*)</b>																																											
MOBILI FORNITI CON ANTA: <b>TELAIO ALLUMINIO E VETRO TEMPERATO SATINATO</b> <i>supplied cabinets with door: aluminium frame and tempered satined glass</i>							<table border="1"> <thead> <tr> <th>(*)</th> <th>STRUTTURA</th> <th><i>structure</i></th> </tr> </thead> <tbody> <tr> <td>166</td> <td>NOCE PAVIA</td> <td><i>pavia walnut</i></td> </tr> <tr> <td>440</td> <td>BIANCO BR.</td> <td><i>br. white</i></td> </tr> <tr> <td>551</td> <td>ANTRACITE</td> <td><i>anthracite</i></td> </tr> <tr> <td>844</td> <td>STONE GREY</td> <td><i>stone grey</i></td> </tr> </tbody> </table>	(*)	STRUTTURA	<i>structure</i>	166	NOCE PAVIA	<i>pavia walnut</i>	440	BIANCO BR.	<i>br. white</i>	551	ANTRACITE	<i>anthracite</i>	844	STONE GREY	<i>stone grey</i>																									
(*)		STRUTTURA	<i>structure</i>																																												
166		NOCE PAVIA	<i>pavia walnut</i>																																												
440	BIANCO BR.	<i>br. white</i>																																													
551	ANTRACITE	<i>anthracite</i>																																													
844	STONE GREY	<i>stone grey</i>																																													

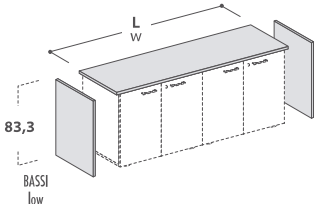
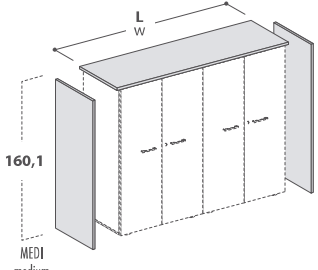
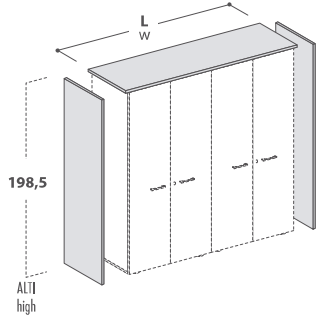
<b>MOBILI ALTI</b> <i>high cabinets</i>		<b>TUTTE LE COMPOSIZIONI CON I MOBILI CONTENITORI DEVONO ESSERE COMPLETATE CON TOP + 2 FIANCHI FINALI (VEDI PAG. 15)</b> <i>always complete the compositions with top + 2 final side panels (please see page 15)</i>						
DESCRIZIONE <i>description</i>	L <i>w</i>	CODICE <i>code</i>	KG	M <sup>3</sup>	COLLI	PREZZO <i>price</i>	(*) CODICE FINITURA <i>(*) finish code</i>	
MOBILE ALTO A GIORNO L.90 <i>open high cabinet w 90 cms</i>   ART. 835  ART. 836  L.90 x p.44,5 x H.196,7	<b>CARCASSA PER ANTE INTERE SOLO LEGNO</b> <i>structure for whole wooden doors only</i>						(*)	
	L.90	155	<b>835 (*)</b>	73	0,162	3	<b>€ 242,00</b>	STRUTTURA <i>structure</i>
	<b>CARCASSA PER ANTE SPEZZATE LEGNO E TUTTE LE TIPOLOGIE DI ANTE VETRO</b> <i>structure for split wooden doors and all types glass doors</i>						(*)	
	L.90	155	<b>836 (*)</b>	73	0,162	3	<b>€ 242,00</b>	166 NOCE PAVIA <i>pavia walnut</i> 440 BIANCO BR. <i>br. white</i> 551 ANTRACITE <i>anthracite</i> 844 STONE GREY <i>stone grey</i>
MOBILE ALTO L.90 CON 2 ANTE LEGNO CON SERRATURA <i>high cabinet w 90 cms with 2 wooden doors with lock</i>   L.90 x p.46,3 x H.196,7	<b>CARCASSA PER ANTE INTERE SOLO LEGNO</b> <i>structure for whole wooden doors only</i>						(*)	
	L.90	155	<b>895 (*)</b>	97	0,247	4	<b>€ 367,00</b>	166 NOCE PAVIA <i>pavia walnut</i> 440 BIANCO BR. <i>br. white</i>
MOBILE ALTO L.90 CON 2 ANTE LEGNO CON SERRATURA E 2 APPENDIABITI ESTRAIBILI <i>high cabinet w 90 cms with 2 wooden doors with lock and 2 pull-out clothes-hanger rails</i>   L.90 x p.46,3 x H.196,7	<b>CARCASSA PER ANTE INTERE SOLO LEGNO</b> <i>structure for whole wooden doors only</i>						VERSIONE MONO-COLORE / <i>single-color version</i>	
	<b>CARCASSA PER ANTE SPEZZATE LEGNO E TUTTE LE TIPOLOGIE DI ANTE VETRO</b> <i>structure for split wooden doors and all types glass doors</i>						(*)	
	L.90	155	<b>896 (*)</b>	82	0,21	4	<b>€ 341,00</b>	166 NOCE PAVIA <i>pavia walnut</i> 440 BIANCO BR. <i>br. white</i>
MOBILE ALTO L.90 CON 2 ANTE LEGNO E 2 ANTE VETRO CON SERRATURE <i>high cabinet w 90 cms with 2 wooden doors and 2 glass doors with locks</i>   L.90 x p.46,3 x H.196,7	<b>CARCASSA PER ANTE INTERE SOLO LEGNO</b> <i>structure for whole wooden doors only</i>						(*)	
	L.90	155	<b>892 (*)</b>	100	0,26	7	<b>€ 504,00</b>	166 NOCE PAVIA <i>pavia walnut</i> 440 BIANCO BR. <i>br. white</i>
	<b>MOBILE FORNITO CON ANTE: TELAIO ALLUMINIO E VETRO TEMPERATO SATINATO</b> <i>supplied cabinet with doors: aluminium frame and tempered satined glass</i>						VERSIONE BI-COLORE / <i>double-color version</i>	
	<b>CARCASSA PER ANTE SPEZZATE LEGNO E TUTTE LE TIPOLOGIE DI ANTE VETRO</b> <i>structure for split wooden doors and all types glass doors</i>						(*)	
	L.90	155	<b>897 (*)</b>	102	0,266	6	<b>€ 538,00</b>	166 NOCE PAVIA <i>pavia walnut</i> 440 BIANCO BR. <i>br. white</i> 551 ANTRACITE <i>anthracite</i> 844 STONE GREY <i>stone grey</i>
MOBILE ALTO L.90 CON 2 ANTE VETRO CON SERRATURA <i>high cabinet w 90 cms with 2 glass doors with lock</i>   L.90 x p.46,3 x H.196,7	<b>CARCASSA PER ANTE INTERE SOLO LEGNO</b> <i>structure for whole wooden doors only</i>						(*)	
	L.90	155	<b>897 (*)</b>	102	0,266	6	<b>€ 538,00</b>	166 NOCE PAVIA <i>pavia walnut</i> 440 BIANCO BR. <i>br. white</i> 551 ANTRACITE <i>anthracite</i> 844 STONE GREY <i>stone grey</i>
	<b>MOBILI FORNITI CON ANTE: TELAIO ALLUMINIO E VETRO TEMPERATO SATINATO</b> <i>supplied cabinets with doors: aluminium frame and tempered satined glass</i>						(*)	
	L.90	155	<b>897 (*)</b>	102	0,266	6	<b>€ 538,00</b>	166 NOCE PAVIA <i>pavia walnut</i> 440 BIANCO BR. <i>br. white</i> 551 ANTRACITE <i>anthracite</i> 844 STONE GREY <i>stone grey</i>

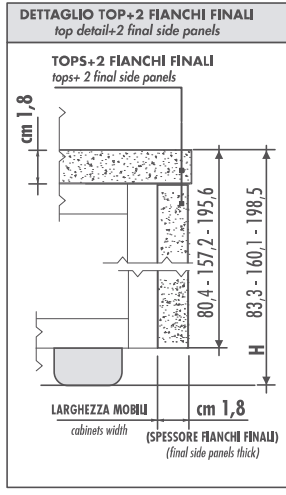
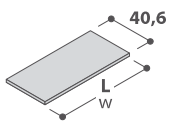
TOP + 2 FIANCHI FINALI							
top + 2 final side panels							
DESCRIZIONE description	L w	CODICE code	KG	M <sup>3</sup>	COLLI	PREZZO price	(*) CODICE FINITURA (* finish code)
TOP + 2 FIANCHI FINALI BASSI top + 2 low final side panels   L. x p.46,9 x sp.1,8	L.93,9	155 <b>480</b> (*)	17	0,049	2	€ 74,00	
	L.138,8	155 <b>481</b> (*)	20	0,059	2	€ 85,00	
	L.183,8	155 <b>482</b> (*)	23	0,07	2	€ 97,00	
	L.228,8	155 <b>483</b> (*)	26	0,073	2	€ 108,00	
	L.273,8	155 <b>484</b> (*)	28	0,089	2	€ 120,00	
TOP + 2 FIANCHI FINALI MEDI top + 2 medium final side panels   L. x p.46,9 x sp.1,8	L.93,9	155 <b>485</b> (*)	27	0,073	2	€ 112,00	
	L.138,8	155 <b>486</b> (*)	30	0,083	2	€ 123,00	(*)
	L.183,8	155 <b>487</b> (*)	33	0,094	2	€ 135,00	166 NOCE PAVIA pavia walnut
	L.228,8	155 <b>488</b> (*)	36	0,097	2	€ 146,00	440 BIANCO BR. br. white
	L.273,8	155 <b>489</b> (*)	38	0,113	2	€ 158,00	704 ROVERE GREY grey oak
							733 ROVERE oak
TOP + 2 FIANCHI FINALI ALTI top + 2 high final side panels   L. x p.46,9 x sp.1,8	L.93,9	155 <b>490</b> (*)	31	0,081	2	€ 129,00	
	L.138,8	155 <b>491</b> (*)	34	0,092	2	€ 140,00	
	L.183,8	155 <b>492</b> (*)	37	0,102	2	€ 152,00	
	L.228,8	155 <b>493</b> (*)	40	0,106	2	€ 163,00	
	L.273,8	155 <b>494</b> (*)	42	0,122	2	€ 175,00	
<div style="text-align: center;">  <p><b>LE MISURE SONO COMPRESSE DI TOP E FIANCHI FINALI</b> the measurements are including of the top and final side panels</p> </div> <div style="text-align: center;"> <p><b>DETTAGLIO TOP+2 FIANCHI FINALI</b> top detail+2 final side panels</p>  </div>							
RIPIANI REGISTRABILI PER MOBILI							
adjustable shelves for cabinets							
1 RIPIANO REGISTRABILE SUPPLEMENTARE PER MOBILI 1 adjustable additional shelf for cabinets   L. x p.40,6 x H.2,5	L.41,2	155 <b>457</b> (*)	3	0,009	1	€ 14,00	(*)
	0,36 L.86,2	155 <b>458</b> (*)	6	0,018	1	€ 22,00	STRUTTURA structure
							166 NOCE PAVIA pavia walnut
							440 BIANCO BR. br. white
							551 ANTRACITE anthracite
							844 STONE GREY stone grey

**KIT AMMORTIZZATORI (PER ANTE LEGNO)**

dampers set (for wooden doors)

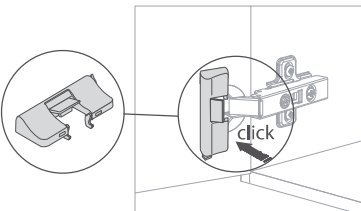
DESCRIZIONE description	L w	CODICE code	KG	M <sup>3</sup>	COLLI	PREZZO price	(*) CODICE FINITURA (*) finish code
KIT AMMORTIZZATORI PER ANTE LEGNO dampers kit for soft-close wooden doors  	1 Pz.	114 <b>354</b> (*)	1	0,001	1	<b>€ 8,00</b>	(*) 000 ARGENTO silver
	2 Pz.	114 <b>355</b> (*)	1	0,001	1	<b>€ 12,00</b>	
	3 Pz.	114 <b>356</b> (*)	1	0,001	1	<b>€ 16,00</b>	

**Applicazione ammortizzatore: / Damper application:**

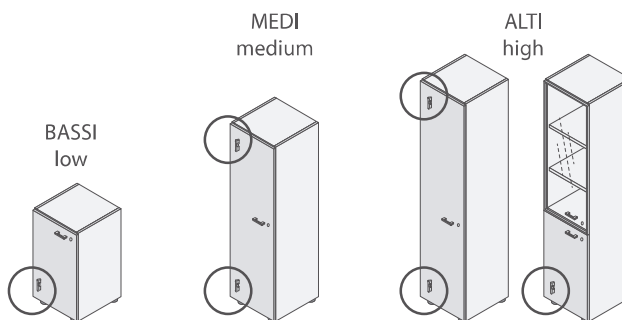



**DESCRIZIONE TECNICA**

# DELTA EVO

**SCRIVANIE CON ALLUNGO COMPLANARE E ALLUNGO CONTENITORE**

Le scrivanie sono di forma rettangolare e sono disponibili nella versione con basamento legno.

Piani, fianchi e schiene di scrivanie sono realizzati con pannelli di particelle di legno spessore mm 35 nobilitati in melaminico.

I piani e i fianchi sono rifiniti perimetralmente con bordo in ABS spessore mm 2 in tinta con la superficie.

Le schiene sono rifinite perimetralmente con bordo melaminico di spessore mm 0,4 in tinta con la superficie.

I fianchi strutturali sono costituiti da due pannelli aggregati tra di loro tramite un distanziale in ABS e sono dotati di scarpetta in nylon alla quale viene applicato un piedino livellatore. Sui fianchi sono applicati dei distanziali in ABS per il collegamento con i piani.

L'allungo contenitore è costituito da una struttura sospesa realizzata con pannelli di particelle di legno spessore mm 18 nobilitati in melaminico, rifiniti perimetralmente con bordo melaminico di spessore mm 0,4 in tinta con la superficie.

L'allungo può essere completato, nel vano centrale, con due cassette di cui uno completo di serratura.

Le scrivanie sono disponibili nella versione mono-colore: ROVERE 03, ROVERE GREY 04, NOCE PAVIA 06, BIANCO BR. 69 oppure nella versione bi-colore in abbinamento alle strutture: STONE GREY 44, ANTRACITE 55, BIANCO BR. 69.

**KIT 2 CASSETTI PER ALLUNGO CONTENITORE**

I frontali sono realizzati con pannello di particelle di legno sp. mm 18 nobilitato melaminico e disponibili nei colori: ROVERE 03, ROVERE GREY 04, NOCE PAVIA 06, AMARANTO 33, STONE GREY 44, ANTRACITE 55, BIANCO BR. 69. I bordi perimetrali sono in ABS mm 2 in tinta con la superficie. Il cassetto superiore è dotato di serratura.

Le spondine sono in fibre legnose sp. mm 12 rivestite in PVC nero, il fondo è in fibra dello spessore di mm 3. Le guide scorrevoli sono del tipo in metallo con cuscinetti in nylon dotati di fine corsa in estrazione e self - closing in chiusura.

Le maniglie sono con sagoma a "ponte", interasse mm 64 realizzate in polipropilene, fornite in tinta unita in abbinamento al colore dei frontali.

**TAVOLO RIUNIONE CIRCOLARE CON BASAMENTO A COLONNA**

Costituito da: piano e basamento metallico.

Piano realizzato con pannello di particelle di legno spessore mm 35 nobilitato in melaminico, rifinito perimetralmente con bordo in ABS spessore mm 2 in tinta con la superficie. Il piano è disponibile nei colori : ROVERE 03, ROVERE GREY 04, NOCE PAVIA 06, BIANCO BR. 69.

Basamento metallico composto da: base circolare Ø590mm, tubo verticale e crociera superiore.

Il tubo verticale ha una sezione che parte alla base con un Ø128mm e poi sale a un Ø89mm. La crociera è realizzata con lamiera metallica sp. mm 4 dotata di asole per il fissaggio sottopiano. Il basamento è verniciato a polveri epossidiche: STONE GREY, ANTRACITE, BIANCO.

**TAVOLI RIUNIONE CON BASAMENTO LEGNO**

Piano realizzato con pannello di particelle di legno spessore mm 35 nobilitato in melaminico, rifinito perimetralmente con bordo in ABS spessore mm 2 in tinta con la superficie. E' disponibile con o senza top access integrato, con cornice in plastica stampata colore argento e coperchio realizzato con pannello di particelle di legno sp. mm8 dello stesso colore dei piani.

Il basamento legno è costituito da: 2 fianchi, 2 schiene e un ripiano (vano wire-manager).

I fianchi sono realizzati con pannelli di particelle di legno spessore mm 35 nobilitati in melaminico, rifiniti perimetralmente con bordo in ABS spessore mm 2 in tinta con la superficie. I fianchi strutturali sono dotati di scarpetta in nylon alla quale viene applicato un piedino livellatore.

Le schiene e il ripiano sono realizzati con pannelli di particelle di legno spessore mm 18 nobilitati in melaminico, rifiniti perimetralmente con bordo melaminico di spessore mm 0,4 in tinta con la superficie.

I tavoli riunione sono disponibili nella versione mono-colore: ROVERE 03, ROVERE GREY 04, NOCE PAVIA 06, BIANCO BR. 69 oppure nella versione bi-colore in abbinamento alle strutture: STONE GREY 44, ANTRACITE 55, BIANCO BR. 69.

**CASSETTIERE E MOBILI DI SERVIZIO**

Struttura realizzata con pannello di particelle legno sp. mm 18 nobilitato in melaminico, disponibile nei colori: STONE GREY 44, ANTRACITE 55, BIANCO BR. 69 rifinita perimetralmente con bordo melaminico mm 0.4.

I frontali, top e schiena sono realizzati con pannello di particelle di legno sp. mm 18 nobilitato melaminico e disponibili nei colori: ROVERE 03, ROVERE GREY 04, NOCE PAVIA 06, BIANCO BR. 69. I bordi perimetrali sono in ABS mm 2 in tinta con la superficie.

I cassetti in legno sono dotati di serratura centralizzata, le spondine sono in fibre legnose sp. mm 12 rivestite in PVC nero, il fondo è in fibra dello spessore di mm 3. Le guide scorrevoli sono del tipo in metallo con cuscinetti in nylon dotati di fine corsa in estrazione e self - closing in chiusura.

Le maniglie sono con sagoma a "ponte", interasse mm 64 realizzate in polipropilene, fornite in tinta unita in abbinamento al colore delle ante e frontali.

Le cassettiere su ruote, sono montate su rotelle piroettanti in nylon grigio di cui le due anteriori dotate di freno di sicurezza.

I mobili di servizio poggiano su piedini regolabili in nylon.

**CONTROMOBILE L.180**

La struttura è realizzata con pannelli di particelle di legno di spessore mm 18 nobilitati in melaminico rifiniti perimetralmente con bordo melaminico di spessore mm 0,4 in tinta con la superficie. Il mobile appoggia su una zoccolatura H.mm.100.

Il top è realizzato con pannello di particelle di legno sp. mm 18 nobilitato in melaminico. I bordi perimetrali sono in ABS spessore mm 2 in tinta con la superficie. Il contromobile L.180 è disponibile nei colori: ROVERE 03, ROVERE GREY 04, NOCE PAVIA 06, STONE GREY 44, ANTRACITE 55, BIANCO BR. 69.

**CONTROMOBILE L.120**

La struttura è realizzata con pannelli di particelle di legno di spessore mm 18 nobilitati in melaminico rifiniti perimetralmente con bordo melaminico di spessore mm 0,4 in tinta con la superficie. La base è dotata di piedini livellatori.

Il top è realizzato con pannello di particelle di legno sp. mm 18 nobilitato in melaminico. I bordi perimetrali sono in ABS spessore mm 2 in tinta con la superficie. Il contromobile L.120 è disponibile nei colori: ROVERE 03, ROVERE GREY 04, NOCE PAVIA 06, STONE GREY 44, ANTRACITE 55, BIANCO BR. 69.

### ANTE PER CONTROMOBILI L.180-120

Le ante dei contromobili, fornite separatamente, sono realizzate con pannelli di particelle di legno di spessore mm 18 nobilitati in melaminico con e rifiniti perimetralmente con bordo in ABS di spessore mm 2 in tinta con la superficie.

La maniglia con sagoma a "ponte", interasse mm 64 realizzata in polipropilene, fornita in tinta unita in abbinamento al colore delle ante. Sono disponibili nei colori: ROVERE 03, ROVERE GREY 04, NOCE PAVIA 06, BIANCO BR. 69, AMARANTO 33.

### ELEMENTO LIBRERIA PER CONTROMOBILI L.180-120

Interamente realizzato con pannelli di particelle di legno di spessore mm 12 nobilitati in melaminico rifiniti perimetralmente con bordo melaminico di spessore mm 0,4 in tinta con la superficie.

E' disponibile nei colori: AMARANTO 33, STONE GREY 44, ANTRACITE 55, BIANCO BR. 69.

Può essere inserito nel vano a giorno dei contromobili.

### MOBILI CONTENITORI BASSI, MEDI E ALTI:

Struttura costituita da: base, cappello, due fianchi e schiena (da sp. mm 18 inserita in fresata).

E' realizzata con pannelli di particelle legno sp. mm 18 nobilitati in melaminico, disponibili nei colori : NOCE PAVIA 06, STONE GREY 44, ANTRACITE 55, BIANCO BR. 69, rifiniti perimetralmente con bordo melaminico mm 0,4. Sulla base sono inseriti piedini regolabili in altezza, in nylon nero ( 4 su mobili L.45, 5 su mobili L.90), con campo di regolazione di mm 15.

I cassetti in legno sono dotati di spondine sono in fibre legnose spessore mm 12 rivestite in PVC nero, il fondo è in fibra dello spessore di mm. 3. Le guide scorrevoli sono del tipo in metallo con cuscinetti in nylon dotati di fine corsa in estrazione e self-closing in chiusura.

Ripiani realizzati con pannelli di particelle legno sp. mm 25 nobilitato in melaminico , disponibile nei colori : NOCE PAVIA 06, STONE GREY 44, ANTRACITE 55, BIANCO BR. 69, rifiniti perimetralmente con bordo melaminico mm 0,4 in tinta con la superficie. Sono dotati di ferramenta a scomparsa, posizionabili in altezza con passo di 32mm. (A richiesta sono disponibili ripiani registrabili in lamiera di acciaio)

I frontali e le ante sono realizzati con pannello di particelle di legno sp. mm 18 nobilitato melaminico e disponibili nei colori: ROVERE 03, ROVERE GREY 04, NOCE PAVIA 06, BIANCO BR. 69. I bordi perimetrali sono in ABS mm 2 in tinta con la superficie. Le cerniere sono del tipo ad ala metallica con apertura a 110°, complete di basi, con regolazione 3D.

Le cerniere delle ante legno possono essere accessoriate con kit ammortizzatori, forniti a parte, per una chiusura soft-close.

Le ante vetro sono disponibili con telaio alluminio, con vetro temperato satinato sp. mm 4, con serratura e maniglia a "ponte" colore ARGENTO;

Le ante legno basse e medie sono dotate di serratura a paletto, le ante alte sono dotate di serratura ad aste rotanti con 2 punti di chiusura. Tutte le ante con serratura hanno il cilindro estraibile e sono fornite con doppia chiave pieghevole anti-infortunistica.

La maniglia con sagoma a "ponte", interasse mm 64 realizzata in polipropilene, fornita in tinta unita in abbinamento al colore delle ante e dei frontali.

Tutte le composizioni con i mobili contenitori devono essere completate con set top+fianchi finali .

### TOP E FIANCHI FINALI

Sono realizzati con pannelli di particelle di legno di spessore mm 18 nobilitati in melaminico, disponibili nei colori: ROVERE 03, ROVERE GREY 04, NOCE PAVIA 06, BIANCO BR. 69. I bordi perimetrali sono in ABS spessore mm 2 in tinta con la superficie.

### IMBALLO

Tutti i componenti sono forniti smontati ed imballati con involucro pieghevole in cartone triplo, listelli di protezione perimetrale e per i riempimenti ove occorre. Gli angoli sono protetti , ove occorre, con parasigoli anti-urto. La chiusura dell'imballo avviene mediante nastro adesivo e reggetta in nylon termosaldato.

Le cassettiere sono fornite montate, protette sui lati con angolari in polistirolo ed imballate con foglia di polietilene termoretraibile.

CARATTERISTICHE FISICO-MECCANICHE DEI PANNELLI DI PARTICELLE DI LEGNO DI SPESSORE mm 18 NOBILITATI IN MELAMINICO:		
DESCRIZIONE	VALORE MINIMO	NORMA DI RIFERIMENTO
Massa volumica	650 Kg / m <sup>3</sup> ± 10%	UNI EN 323 :1994
Umidità relativa	5 - 13%	UNI EN 322 :1994
Tolleranza spessore	± 0,3 mm	UNI EN 324-1/1994
Rigonfiamento a 24 ore	15%	UNI EN 317 :1994
Distacco strati esterni	0,8 Mpa	UNI EN 311 :2003
Flessione statica	16 Mpa	UNI EN 310 :1994
Modulo di elasticità	1600 Mpa	UNI EN 310 :1994
Estrazione viti sui bordi	> 400 N	UNI EN 320 :1994
Contenuto di formaldeide	≤ a 3,5 mg H2CO (m <sup>2</sup> x h)	UNI EN ISO 12460 - 3:2015

Emesso da Ufficio Tecnico  
LAS MOBILI  
Data ultima revisione:  
GENNAIO 2020

**TECHNICAL DESCRIPTION**

# DELTA EVO

**DESKS WITH COPLANAR EXTENSIONS AND CONTAINER EXTENSION**

The desks are rectangular and are available in the version with a wooden base.

Tops, sides and modesty panels of desks are made of 35mm thick particleboard panels that are melamine faced. Tops and sides are finished perimetrimally with 2mm thick ABS edge matching the surface. The modesty panels are finished with 0.4 mm thick melamine edge matching the surface.

The structural sides are formed of two panels which are joined by a spacer in ABS and are equipped with a nylon tip to which a leveller foot is applied. There are ABS spacers on the sides and modesty panels for joining to the tops.

The container extension is constituted of a suspended structure made of 18 mm thick melamine faced particleboard panel, perimetrimally finished with 0.4 mm thick melamine edge matching the surface.

In the central part there is a compartment for inserting 2 drawers supplied separately.

The desks are available in monochrome version: OAK 03, GREY OAK 04, PAVIA WALNUT 06, BR. WHITE 69 or in the double-colour version in combination with the structures: STONE GREY 44, ANTHRACITE 55, BR. WHITE 69.

**KIT OF 2 DRAWERS FOR CONTAINER EXTENSION**

The fronts are made of 18 mm thick melamine faced particleboard panels and available in colours: OAK 03, GREY OAK 04, PAVIA WALNUT 06, AMARANTH 33, STONE GREY 44, ANTHRACITE 55, BR. WHITE 69. They are perimetrimally finished with 2 mm thick ABS edge matching the surface.

The upper drawer is fitted with a lock.

The sides of the drawers are made of 12 mm wood fibreboard covered by black PVC and the drawer bottoms are made of 3 mm thick fibreboard. The sliding guides are made of metal and have nylon buffers fitted with limit switches during opening and self-closing limit switches during closing.

The handles are of "Bridge" shaped design, made of polypropylene, centre distance 64 mm, supplied to match the colour of the fronts.

**CIRCULAR MEETING TABLE WITH COLUMN BASE**

Composed of: top and column base.

Top is made of 35 mm thick particleboard panel that is melamine faced. It is finished perimetrimally with 2 mm thick ABS edge matching the surface.

It is available in the following colours: OAK 03, GREY OAK 04, PAVIA WALNUT 06, BR. WHITE 69.

Metal base is composed of: circular base Ø590mm, vertical column and upper plate.

The column is made of a tube that has a section that starts at the base with Ø128 mm and then rises to Ø 89 mm. The top plate is made of metal sheet 4 mm thick with holes for fixing under the top. The metal base is painted with epoxy powder in colours: STONE GREY, ANTHRACITE, WHITE.

**MEETING TABLES WITH PANEL BASE**

Top is made of 35 mm thick particleboard panel that is melamine faced. It is finished perimetrimally with 2 mm thick ABS edge matching the surface.

It is available with or without top access, made of silver printed plastic frame and cover made of 8 mm thick melamine faced particleboard panel in the same colour as the worktop surface.

The wooden structure consists of : two sides, two modesty panels and a shelf (wire-manager space).

The sides are made of 35 mm thick particleboard panels that are melamine faced, finished perimetrimally with 2 mm thick ABS edge matching the surface.

The side panels are equipped with a nylon tip to which a leveller foot is applied.

The modesty panels and the shelf are made of 18 mm thick particleboard panels that are melamine faced, they are finished with 0.4 mm thick melamine edge matching the surface.

The meeting tables are available in monochrome version: OAK 03, GREY OAK 04, PAVIA WALNUT 06, BR. WHITE 69 or in the double-colour version in combination with the structures: STONE GREY 44, ANTHRACITE 55, BR. WHITE 69.

**PEDESTALS ON WHEELS AND SERVICE UNITS ON FEET**

Structure made of 18 mm thick melamine faced particleboard panels, available in colours: STONE GREY 44, ANTHRACITE 44, BR. WHITE 69 perimetrimally finished with 0.4 mm melamine edge.

The fronts, top and back panels are made of 18 mm thick melamine faced particleboard panels and are available in colours: OAK 03, GREY OAK 04, PAVIA WALNUT 06, BR. WHITE 69. They are finished perimetrimally with 2mm ABS edge matching the surface.

The wood drawers are fitted with a central lock; the sides of the drawers are made of 12 mm wood fibreboards covered by black PVC and the drawer bottoms are made of 3mm thick fibreboard. The sliding guides are made of metal and have nylon buffers fitted with limit switches during opening and self-closing limit switches during closing.

The handles are of "Bridge" shaped design, made of polypropylene, centre distance 64 mm, supplied to match the colour of the doors and fronts.

The mobile pedestals are mounted on grey nylon pivoting wheels, the two front wheels are equipped with a safety brake.

The service units are fitted with levelling feet.

**CREDENZA L.180**

The structure is made of particleboard panels 18 mm thick, melamine faced, finished with 0.4 mm thick melamine edge matching the surface.

The credenza is accommodated on a plinth H. 100 mm.

The top is made of particleboard panel 18 mm thick, melamine faced and finished with 2 mm thick ABS edge matching the surface.

The credenza L.180 cm is available in colours: OAK 03, GREY OAK 04, PAVIA WALNUT 06, STONE GREY 44, ANTHRACITE 55, BR. WHITE 69.

**CREDENZA L.120**

The structure is made of particleboard panels 18 mm thick, melamine faced, finished with 0.4 mm thick melamine edge matching the surface.

The base is equipped with height-adjustable feet in black nylon.

The top is made of particleboard panel 18 mm thick, melamine faced and finished with 2 mm thick ABS edge matching the surface.

The credenza I. 120 cm is available in colours: OAK 03, GREY OAK 04, PAVIA WALNUT 06, STONE GREY 44, ANTHRACITE 55, BR. WHITE 69.

#### **DOORS FOR CREDENZAS L. 180-120 CM**

The doors (provided separately) are made of particleboard panel 18 mm thick, melamine faced finished with 2 mm thick ABS edge matching the surface.

The handles are of "Bridge" shaped design, made of polypropylene, , centre distance 64 mm, supplied to match the colour of the doors.

The doors are available in colours: OAK 03, GREY OAK 04, PAVIA WALNUT 06, BR. WHITE 69, AMARANTH 33.

#### **BOOKCASE ELEMENT FOR CREDENZAS L. 180-120 CM**

The structure is made of particleboard panels 12 mm thick, melamine faced finished with 0.4 mm thick melamine edge matching the surface. It's available in colours: AMARANTH 33, STONE GREY 44, ANTHRACITE 55, BR. WHITE 69.

It can be inserted into the open compartment of the credenza.

#### **LOW, MEDIUM AND HIGH CABINETS:**

Structure consists of: base, top, two side panels and back (18 mm thick inserted into milling).

Structure made of 18 mm thick particleboards faced with melamine, available in colours : PAVIA WALNUT 06 , STONE GREY 44, ANTHRACITE 55, BR. WHITE 69, finished with 0.4 mm thick melamine edge. Height-adjustable feet in black nylon fixed under the base (4 for cabinets w. 45 cm, 5 for cabinets w. 90 cm), with adjustment range of 15 mm.

The shelves are made of 25 mm thick particleboards faced with melamine, available in colours STONE GREY 44, ANTHRACITE 55, BR. WHITE 69. They are finished with 0.4 mm thick melamine edge matching the surface.

They are equipped with concealed hardware and can be fixed at height pitch of 32 mm.

The fronts and doors are made of 18 mm thick particleboards faced with melamine and available in colours: OAK 03, GREY OAK 04, PAVIA WALNUT 06, BR. WHITE 69. They are finished with 2 mm thick ABS edge matching the surface.

The handles are of "Bridge" shaped design, made of polypropylene, centre distance 64 mm, supplied to match the colour of the doors and fronts.

The hinges have a metal arm with 110 ° opening, complete with bases, with 3D adjustment.

The hinges of wooden doors can be equipped with dampers kit, supplied separately, for a soft-close.

The glass doors feature an aluminium profile extruded frame, 4 mm thick tempered frosted glass, with lock. The handles are of "Bridge" shaped design, made of polypropylene, in SILVER colour. All doors with locks have removable cylinder and are equipped with double folding key (accident prevention).

All compositions with cabinets must be completed with a top+2 final side panels set.

#### **TOPS AND FINAL SIDE PANELS**

They are made of particleboard panels 18 mm thick, melamine faced and are available in colours: OAK 03, GREY OAK 04, PAVIA WALNUT 06, BR. WHITE 69. They are finished with 2mm thick ABS edge matching the surface.

#### **PACKAGING**

All the components are disassembled and packed in triple cardboard box folding packaging, with laths for the perimetrical protection and for filling up, where needed . The corners are protected, where needed, through shock resistant edges protectors. The packing closure occurs through adhesive tape and welded nylon strap.

Pedestals are supplied assembled, protected through polystyrene angle bars on the sides and packed using thermo-retractable polyethylene film.

PHYSICAL-MECHANICAL CHARACTERISTICS OF 18 MM THICK PARTICLEBOARD PANELS, MELAMINE-FACED:		
DESCRIPTION	MINIMUM VALUE	STANDARD NUMBERS
Volume Mass	650 Kg / m <sup>3</sup> ± 10%	UNI EN 323 :1994
Relative Humidity	5 - 13%	UNI EN 322 :1994
Thickness Allowance	± 0,3 mm	UNI EN 324-1/1994
24 hour Swelling	15%	UNI EN 317 :1994
External Surfaces Detachment	0,8 Mpa	UNI EN 311 :2003
Static Flexure	16 Mpa	UNI EN 310 :1994
Elastic Modulus	1600 Mpa	UNI EN 310 :1994
Edge Screws Extraction	> 400 N	UNI EN 320 :1994
Formaldehyde Content	≤ a 3,5 mg H <sub>2</sub> CO (m <sup>2</sup> x h)	UNI EN ISO 12460 - 3:2015

Released by the Technical Office  
of LAS MOBILI  
last revision date:  
JANUARY 2020

\* = INDICARE IL CODICE FINITURA  
 = complete with finish code

CODICE code	DESCRIZIONE description	PAG. page	PREZZO price
114 354 *	KIT 1 AMMORTIZZATORE PER ANTE LEGNO kit 1 damper for soft-close wooden doors	16	€ 8,00
114 355 *	KIT 2 AMMORTIZZATORI PER ANTE LEGNO kit 2 dampers for soft-close wooden doors	16	€ 12,00
114 356 *	KIT 3 AMMORTIZZATORI PER ANTE LEGNO kit 3 dampers for soft-close wooden doors	16	€ 16,00
155 010 *	SCRIVANIA DIREZIONALE L.180 x p.90 executive desk w 180 x d 90 cms	5	€ 363,00
155 011 *	SCRIVANIA DIREZIONALE L.200 x p.90 executive desk w 200 x d 90 cms	5	€ 384,00
155 016 *	SCRIVANIA DIREZIONALE L.160 x p.90 executive desk w 160 x d 90 cms	5	€ 351,00
155 091 *	TAVOLO RIUNIONE CIRCOLARE Ø 120 rounded meeting table Ø 120 cms	9	€ 415,00
155 165 *	SET 2 CASSETTI CON SERRATURA SUPERIORE PER ALLUNGO CONTENITORE drawers set with upper lock for container extension	5	€ 90,00
155 166 *	SCRIVANIA DIREZIONALE L.160 x p.90 CON ALLUNGO DX CONTENITORE executive desk w 160 x d 90 cms with right container extension	5	€ 559,00
155 167 *	SCRIVANIA DIREZIONALE L.180 x p.90 CON ALLUNGO DX CONTENITORE executive desk w 180 x d 90 cms with right container extension	5	€ 571,00
155 168 *	SCRIVANIA DIREZIONALE L.200 x p.90 CON ALLUNGO DX CONTENITORE executive desk w 200 x d 90 cms with right container extension	5	€ 592,00
155 169 *	SCRIVANIA DIREZIONALE L.160 x p.90 CON ALLUNGO SX CONTENITORE executive desk w 160 x d 90 cms with left container extension	5	€ 559,00
155 170 *	SCRIVANIA DIREZIONALE L.180 x p.90 CON ALLUNGO SX CONTENITORE executive desk w 180 x d 90 cms with left container extension	5	€ 571,00
155 171 *	SCRIVANIA DIREZIONALE L.200 x p.90 CON ALLUNGO SX CONTENITORE executive desk w 200 x d 90 cms with left container extension	5	€ 592,00
155 172 *	ALLUNGO LATERALE DX O SX L.100 x p.60 right or left lateral extension w 100 x d 60 cms	6	€ 136,00
155 218 *	SCRIVANIA DIREZIONALE L.180 x p.90 CON ALLUNGO DX executive desk w 180 x d 90 cms with right extension	5	€ 564,00
155 219 *	SCRIVANIA DIREZIONALE L.200 x p.90 CON ALLUNGO DX executive desk w 200 x d 90 cms with right extension	5	€ 585,00
155 220 *	SCRIVANIA DIREZIONALE L.180 x p.90 CON ALLUNGO SX executive desk w 180 x d 90 cms with left extension	5	€ 564,00
155 221 *	SCRIVANIA DIREZIONALE L.200 x p.90 CON ALLUNGO SX executive desk w 200 x d 90 cms with left extension	5	€ 585,00
155 232 *	SCRIVANIA DIREZIONALE L.160 x p.90 CON ALLUNGO DX executive desk w 160 x d 90 cms with right extension	5	€ 552,00
155 233 *	SCRIVANIA DIREZIONALE L.160 x p.90 CON ALLUNGO SX executive desk w 160 x d 90 cms with left extension	5	€ 552,00
155 240 *	TAVOLO RIUNIONE L.210 x p.120 (SENZA TOP ACCESS) meeting table w 210 x d 120 cms (without top access)	9	€ 460,00
155 242 *	TAVOLO RIUNIONE L.210 x p.120 (CON TOP ACCESS) meeting table w 210 x d 120 cms (with top access)	9	€ 506,00
155 252 *	TAVOLO RIUNIONE L.260 x p.120 (SENZA TOP ACCESS) meeting table w 260 x d 120 cms (without top access)	9	€ 538,00
155 253 *	TAVOLO RIUNIONE L.260 x p.120 (CON TOP ACCESS) meeting table w 260 x d 120 cms (with top access)	9	€ 587,00
155 454 *	MOBILE DI SERVIZIO L.140 TERMINALE DX O SX (CON 1 ANTA SCORREVOLE E VANO A GIORNO) right or left terminal service unit w 140 cms (with 1 sliding door and open compartment)	7	€ 264,00
155 457 *	RIPIANO REGISTRABILE SUPPLEMENTARE PER MOBILI L.45 adjustable additional shelf for cabinets w 45 cms	15	€ 14,00
155 458 *	RIPIANO REGISTRABILE SUPPLEMENTARE PER MOBILI L.90 adjustable additional shelf for cabinets w 90 cms	15	€ 22,00
155 462 *	CONTROMOBILE L.180 credenza w 180 cms	8	€ 342,00
155 472 *	CONTROMOBILE L.120 credenza w 120 cms	8	€ 347,00
155 473 *	ELEMENTO LIBRERIA PER CONTROMOBILI bookcase element for credenzas	8	€ 175,00
155 476 *	ANTA BASSA DX O SX PER CONTROMOBILI right or left low wooden door for credenzas	8	€ 32,00
155 477 *	ANTA MEDIA DX O SX PER CONTROMOBILE ART.472 right or left medium wooden door for credenza art.472	8	€ 57,00
155 480 *	TOP L. 93,9 + 2 FIANCHI FINALI BASSI top w 93,9 cms + 2 low final side panels	15	€ 74,00
155 481 *	TOP L. 138,8 + 2 FIANCHI FINALI BASSI top w 138,8 cms + 2 low final side panels	15	€ 85,00

\* = INDICARE IL CODICE FINITURA  
= complete with finish code

CODICE code	DESCRIZIONE description	PAG. page	PREZZO price
155 482 *	TOP L. 183,8 + 2 FIANCHI FINALI BASSI top w 183,8 cms + 2 low final side panels	15	€ 97,00
155 483 *	TOP L. 228,8 + 2 FIANCHI FINALI BASSI top w 228,8 cms + 2 low final side panels	15	€ 108,00
155 484 *	TOP L. 273,8 + 2 FIANCHI FINALI BASSI top w 273,8 cms + 2 low final side panels	15	€ 120,00
155 485 *	TOP L. 93,9 + 2 FIANCHI FINALI MEDI top w 93,9 cms + 2 medium final side panels	15	€ 112,00
155 486 *	TOP L. 138,8 + 2 FIANCHI FINALI MEDI top w 138,8 cms + 2 medium final side panels	15	€ 123,00
155 487 *	TOP L. 183,8 + 2 FIANCHI FINALI MEDI top w 183,8 cms + 2 medium final side panels	15	€ 135,00
155 488 *	TOP L. 228,8 + 2 FIANCHI FINALI MEDI top w 228,8 cms + 2 medium final side panels	15	€ 146,00
155 489 *	TOP L. 273,8 + 2 FIANCHI FINALI MEDI top w 273,8 cms + 2 medium final side panels	15	€ 158,00
155 490 *	TOP L. 93,9 + 2 FIANCHI FINALI ALTI top w 93,9 cms + 2 high final side panels	15	€ 129,00
155 491 *	TOP L. 138,8 + 2 FIANCHI FINALI ALTI top w 138,8 cms + 2 high final side panels	15	€ 140,00
155 492 *	TOP L. 183,8 + 2 FIANCHI FINALI ALTI top w 183,8 cms + 2 high final side panels	15	€ 152,00
155 493 *	TOP L. 228,8 + 2 FIANCHI FINALI ALTI top w 228,8 cms + 2 high final side panels	15	€ 163,00
155 494 *	TOP L. 273,8 + 2 FIANCHI FINALI ALTI top w 273,8 cms + 2 high final side panels	15	€ 175,00
155 597 *	MOBILE BASSO L.45 CON 4 CASSETTI (CON CHIUSURA AMMORTIZZATA) low cabinet w 45 cms with 4 drawers (with soft-close)	11	€ 188,00
155 778 *	MOBILE DI SERVIZIO L.120 CON 3 CASSETTI E 1 ANTA DX (CON CHIUSURA AMMORTIZZATA) service unit w 120 cms with 3 drawers and 1 right wooden door (with soft-close)	7	€ 347,00
155 779 *	MOBILE DI SERVIZIO L.120 CON 3 CASSETTI E 1 ANTA SX (CON CHIUSURA AMMORTIZZATA) service unit w 120 cms with 3 drawers and 1 left wooden door (with soft-close)	7	€ 347,00
155 780 *	CASSETTIERA SU RUOTE 3 CASSETTI (CON SERRATURA) (CON CHIUSURA AMMORTIZZATA) mobile pedestal with 3 drawers (with lock) (with soft-close)	7	€ 204,00
155 800 *	MOBILE BASSO A GIORNO L.45 open low cabinet w 45 cms	11	€ 77,00
155 803 *	MOBILE BASSO L.45 CON 1 ANTA LEGNO DX + SERR. low cabinet w 45 cms with 1 right wooden door + lock	11	€ 108,00
155 804 *	MOBILE BASSO L.45 CON 1 ANTA LEGNO SX + SERR. low cabinet w 45 cms with 1 left wooden door + lock	11	€ 108,00
155 807 *	MOBILE BASSO L.90 CON 2 ANTE LEGNO + SERR. low cabinet w 90 cms with 2 wooden doors + lock	11	€ 165,00
155 809 *	MOBILE BASSO L.45 CON 1 ANTA LEGNO DX + SERR.+FRIGORIFERO DA Lt.38 + GRIGLIA DI AERAZIONE low cabinet w 45 cms with 1 right wooden door + refrigerator 38 liters + airing grill	11	€ 920,00
155 810 *	MOBILE BASSO A GIORNO L.90 open low cabinet w 90 cms	11	€ 113,00
155 815 *	MOBILE MEDIO A GIORNO L.45 open medium cabinet w 45 cms	12	€ 138,00
155 820 *	MOBILE MEDIO A GIORNO L.90 open medium cabinet w 90 cms	12	€ 205,00
155 825 *	MOBILE ALTO A GIORNO L.45 (CARCASSA PER ANTE INTERE LEGNO) open high cabinet w 45 cms (structure for whole wooden doors)	13	€ 166,00
155 826 *	MOBILE ALTO A GIORNO L.45 (CARCASSA PER ANTE SPEZZATE LEGNO E TUTTE LE ANTE VETRO) open high cabinet w 45 cms (structure for split wooden doors and all types glass doors)	13	€ 166,00
155 835 *	MOBILE ALTO A GIORNO L.90 (CARCASSA PER ANTE INTERE LEGNO) open high cabinet w 90 cms (structure for whole wooden doors)	14	€ 242,00
155 836 *	MOBILE ALTO A GIORNO L.90 (CARCASSA PER ANTE SPEZZATE LEGNO E TUTTE LE ANTE VETRO) open high cabinet w 90 cms (structure for split wooden doors and all types glass doors)	14	€ 242,00
155 860 *	MOBILE MEDIO L.45 CON 1 ANTA LEGNO DX + SERR. medium cabinet w 45 cms with 1 right wooden door + lock	12	€ 191,00
155 861 *	MOBILE MEDIO L.45 CON 1 ANTA LEGNO SX + SERR. medium cabinet w 45 cms with 1 left wooden door + lock	12	€ 191,00
155 862 *	MOBILE MEDIO L.45 CON 1 ANTA VETRO DX + SERR. medium cabinet w 45 cms with 1 right glass door + lock	12	€ 272,00
155 863 *	MOBILE MEDIO L.45 CON 1 ANTA VETRO SX + SERR. medium cabinet w 45 cms with 1 left glass door + lock	12	€ 272,00
155 869 *	MOBILE MEDIO L.90 CON 2 ANTE LEGNO + SERR. medium cabinet w 90 cms with 2 wooden doors + lock	12	€ 290,00
155 874 *	MOBILE MEDIO L.90 CON 2 ANTE VETRO + SERR. medium cabinet w 90 cms with 2 glass doors + lock	12	€ 470,00

\* = INDICARE IL CODICE FINITURA  
= complete with finish code

CODICE code	DESCRIZIONE description	PAG. page	PREZZO price
155 879 *	MOBILE ALTO L. 45 CON 1 ANTA LEGNO DX CON SERR. + 1 ANTA VETRO DX CON SERR. high cabinet w 45 cms with 1 right wooden door with lock + 1 right glass door with lock	13	€ 304,00
155 880 *	MOBILE ALTO L. 45 CON 1 ANTA LEGNO SX CON SERR. + 1 ANTA VETRO SX CON SERR. high cabinet w 45 cms with 1 left wooden door with lock + 1 left glass door with lock	13	€ 304,00
155 885 *	MOBILE ALTO L.45 CON 1 ANTA LEGNO DX + SERR. high cabinet w 45 cms with 1 right wooden door + lock	13	€ 245,00
155 886 *	MOBILE ALTO L.45 CON 1 ANTA LEGNO SX + SERR. high cabinet w 45 cms with 1 left wooden door + lock	13	€ 245,00
155 887 *	MOBILE ALTO L.45 CON 1 ANTA VETRO DX + SERR. high cabinet w 45 cms with 1 right glass door + lock	13	€ 313,00
155 888 *	MOBILE ALTO L.45 CON 1 ANTA VETRO SX + SERR. high cabinet w 45 cms with 1 left glass door + lock	13	€ 313,00
155 892 *	MOBILE ALTO L. 90 CON 2 ANTE LEGNO CON SERR. + 2 ANTE VETRO CON SERR. high cabinet w 90 cms with 2 wooden doors with lock+ 2 glass doors with lock	14	€ 504,00
155 895 *	MOBILE ALTO L.90 CON 2 ANTE LEGNO + SERR. high cabinet w 90 cms with 2 wooden doors + lock	14	€ 367,00
155 896 *	MOBILE ALTO PORTA-ABITI L.90 + SERR. High cabinet w 90 cms with wardrobe + lock	14	€ 341,00
155 897 *	MOBILE ALTO L.90 CON 2 ANTE VETRO + SERR. high cabinet w 90 cms with 2 glass doors + lock	14	€ 538,00
<b>OYO</b>			
175 456 *	CANALE PORTACAVI L.108 sheet metal cable tray w 108 cms	6	€ 25,00
175 458 *	CANALE PORTACAVI L.148 sheet metal cable tray w 148 cms	6	€ 34,00
175 787 *	PASSACAVO Ø 80mm cable way Ø 80mm	6	€ 23,00

